

Proportion of event class assigned to signature

Liver-HCC SA269167 Complex

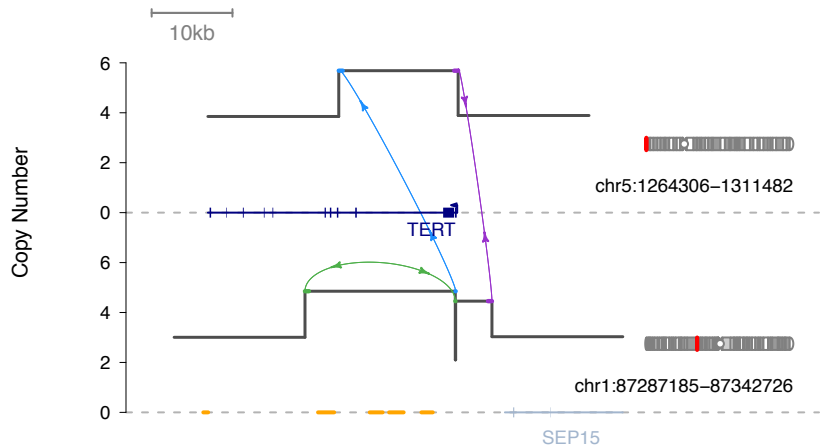

Liver-HCC SA501415 Complex

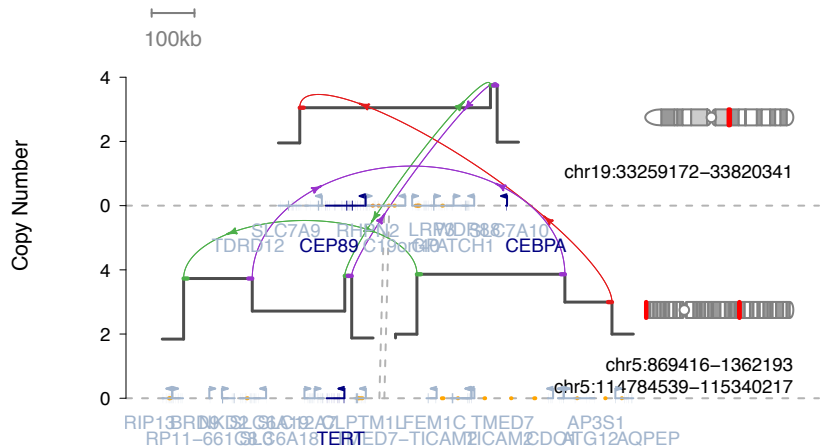

Liver-HCC SA540960 Complex

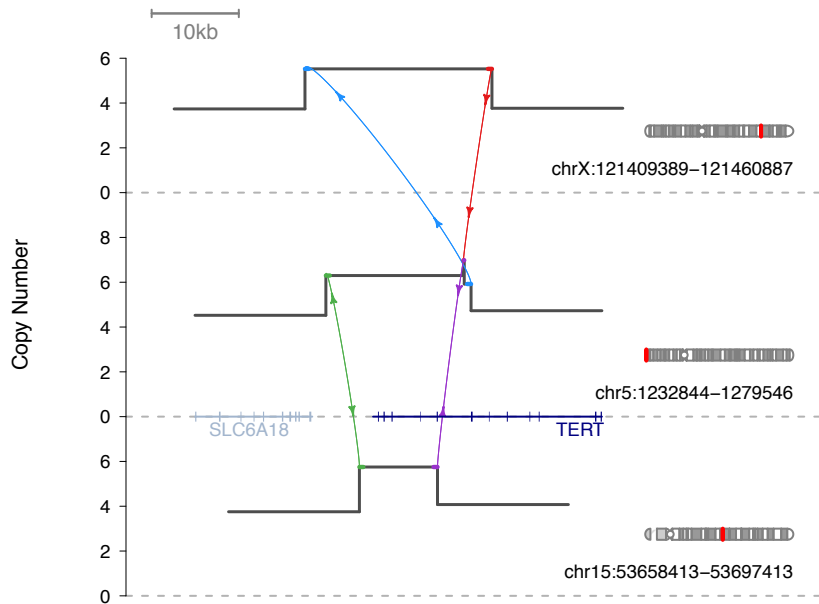

Liver-HCC SA501583 Ins Bridge

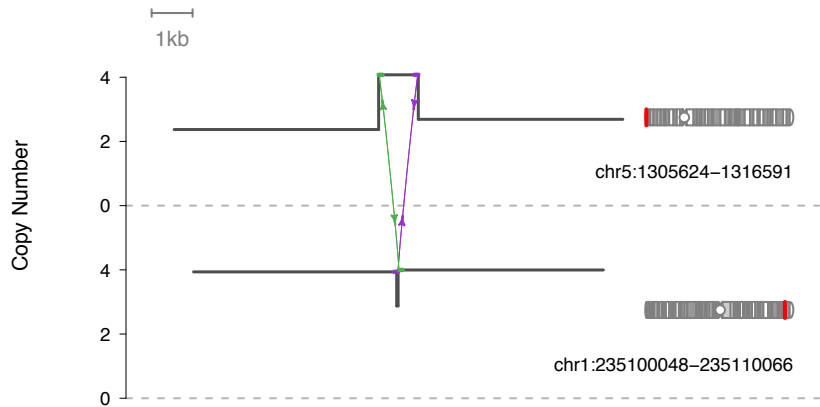

Liver-HCC SA540506 Ins Chain

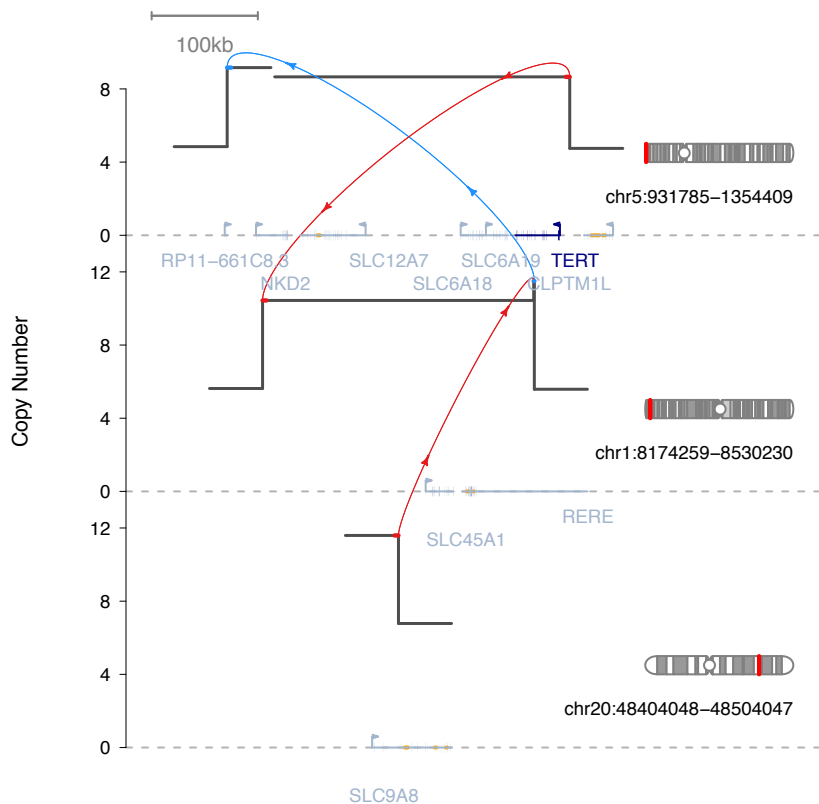

Liver-HCC SA270088 Ins Cycle

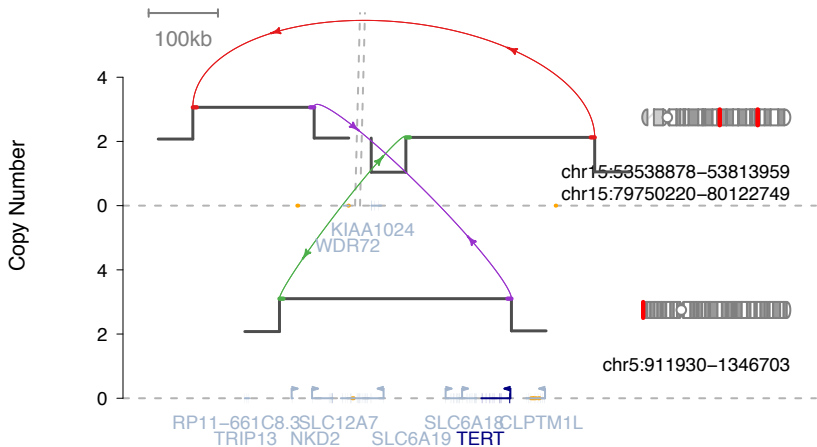

CNS-Medullo SA413862 Ins Cycle

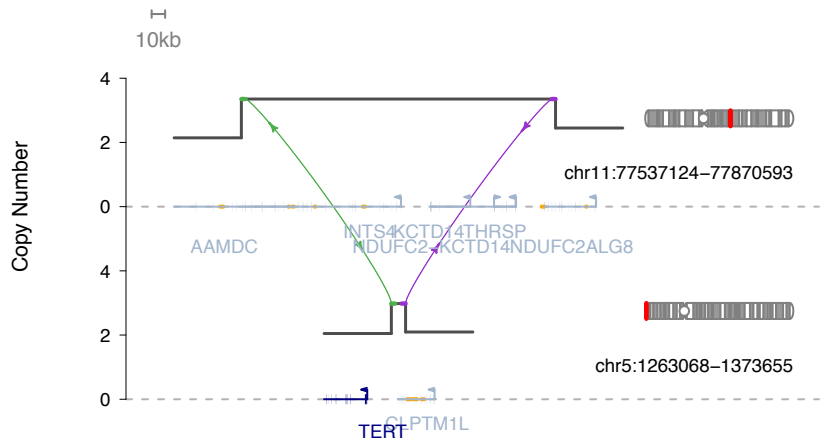

CNS-Medullo SA414143 Ins Cycle

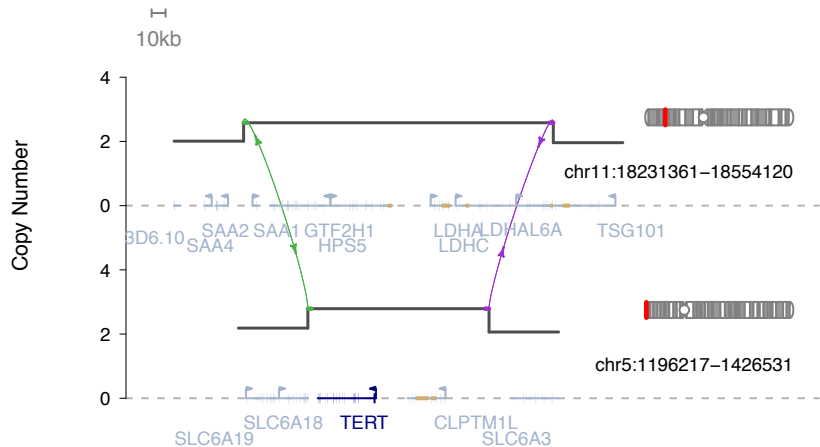

Liver-HCC SA501549 Ins Cycle

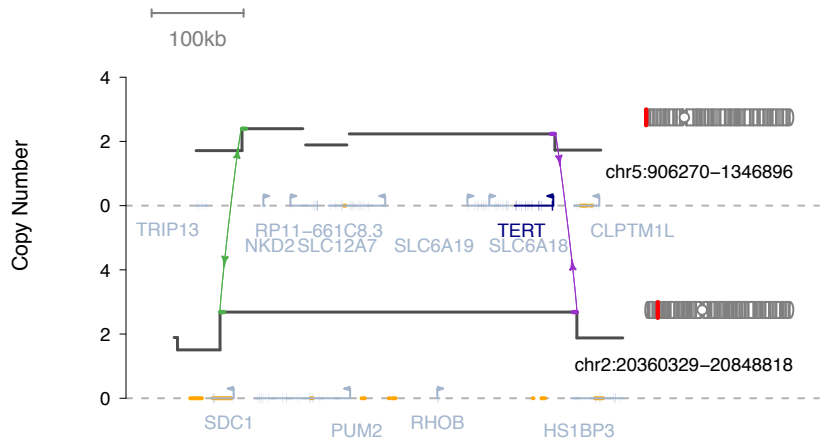

Biliary-AdenoCA SA501598 Ins Cycle

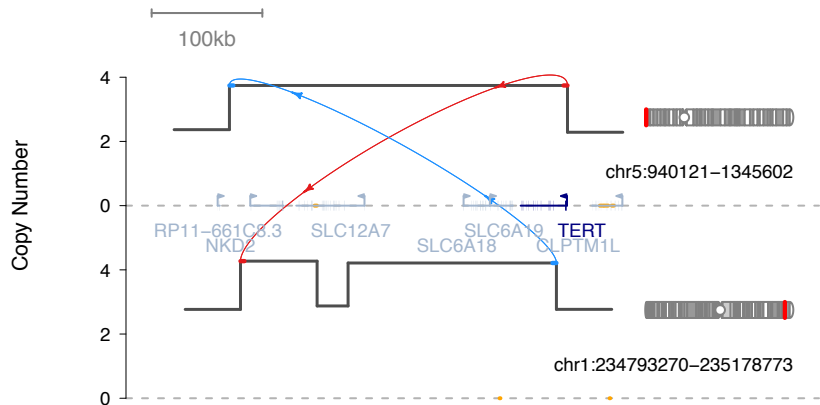

Liver-HCC SA529724 Ins Cycle

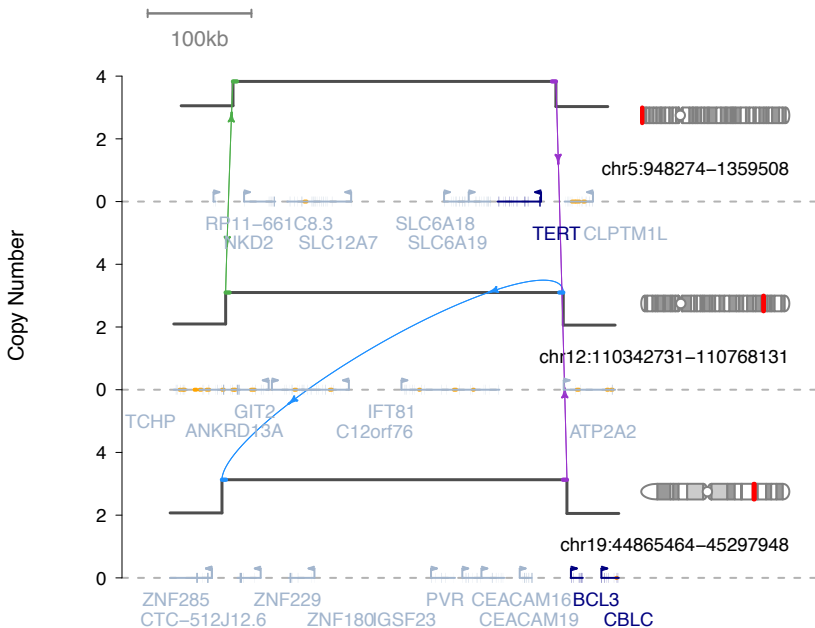

Liver-HCC SA529759 Ins Cycle

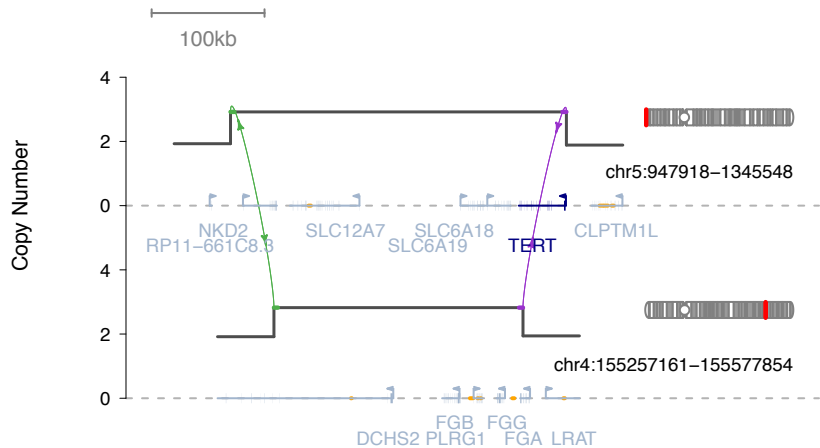

Liver-HCC SA529777 Ins Cycle

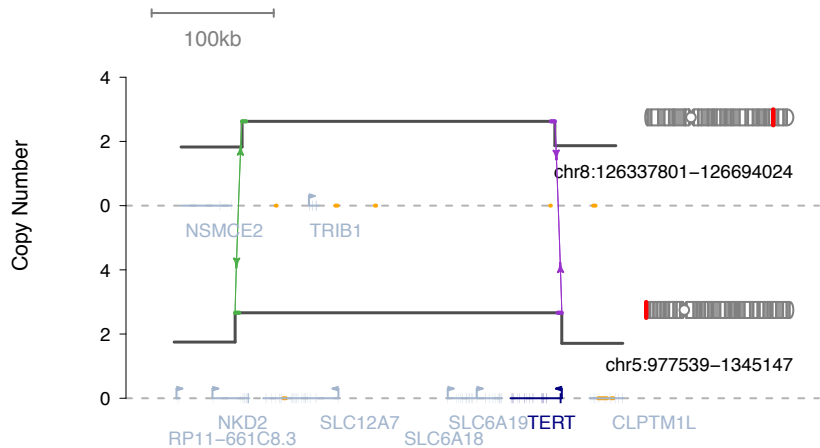

Liver-HCC

TERT expression, log(FPKM)

10.0 -

0.1 -

None

Templ Ins

Other SV near TSS

TERT SV status

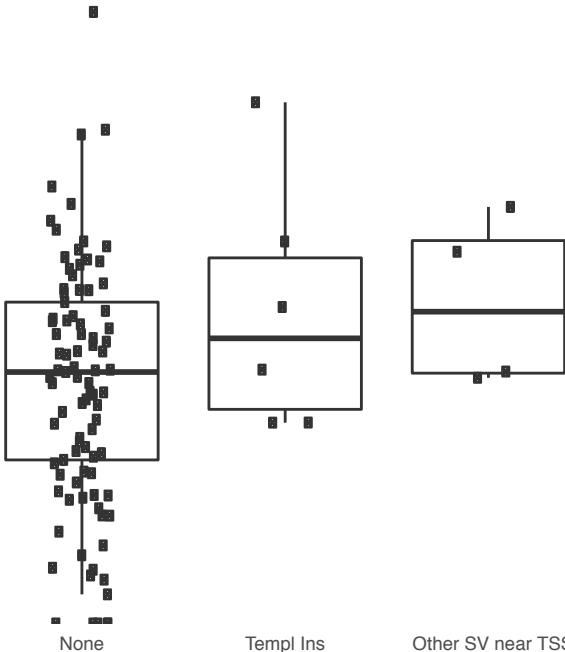

Breast-AdenoCA SA45294 Complex

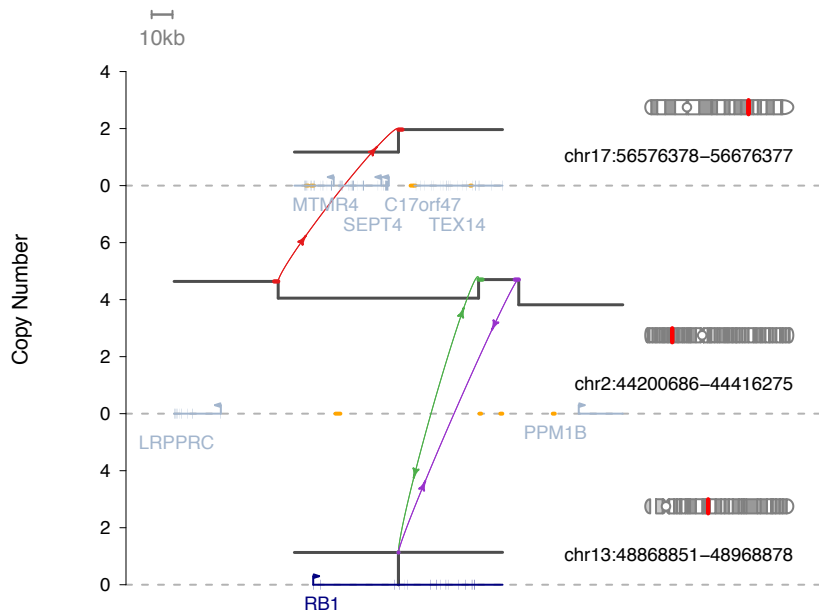

Ovary-AdenoCA SA520096 Ins Bridge

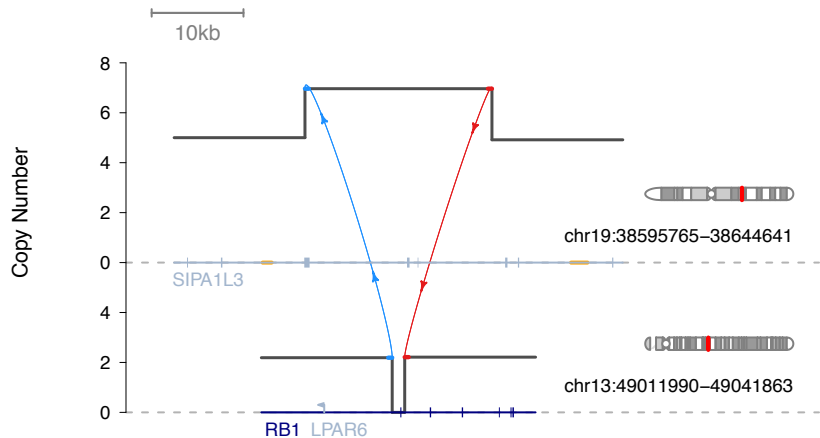

Breast-AdenoCA SA18463 Ins Cycle

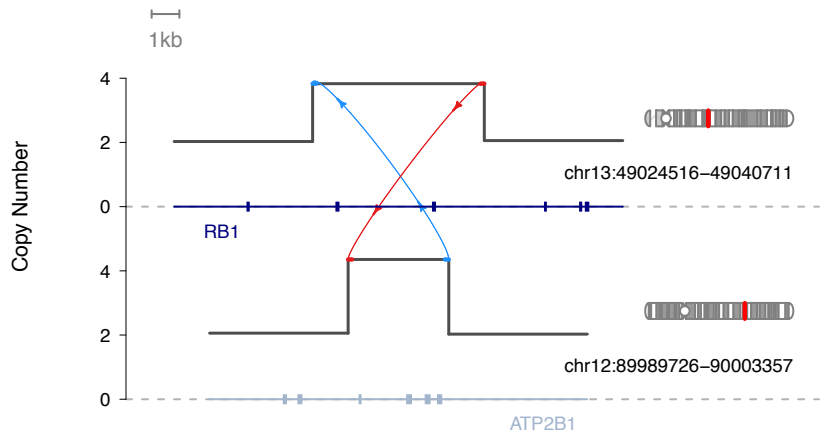

Breast-AdenoCA SA20573 Ins Cycle

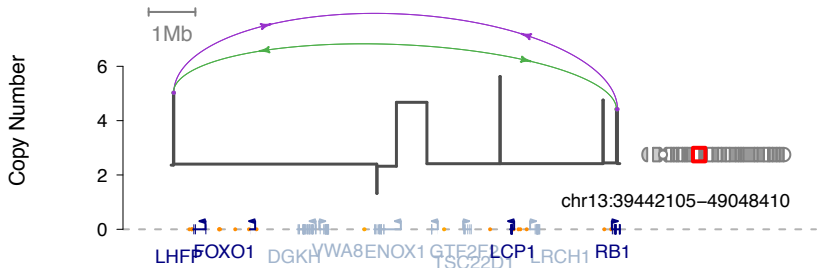

Breast-AdenoCA SA72823 Ins Cycle

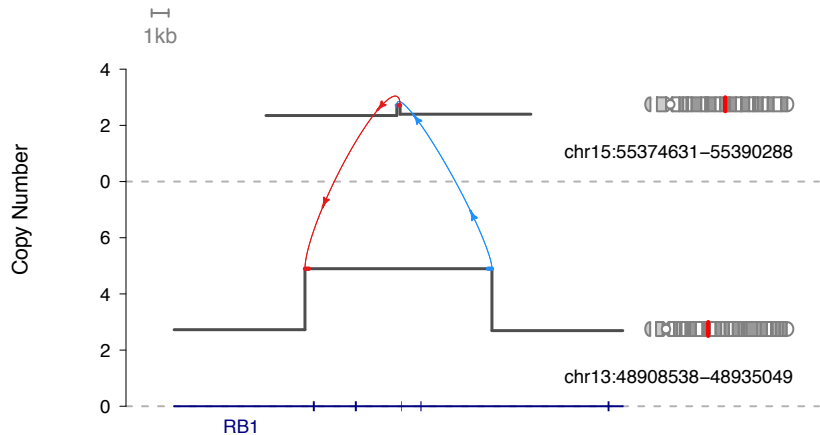

Breast-AdenoCA SA491814 Ins Cycle

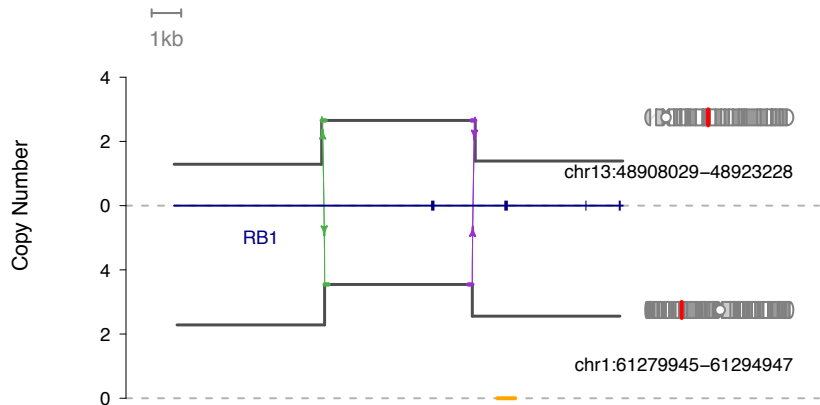

Ovary-AdenoCA SA505821 Ins Cycle

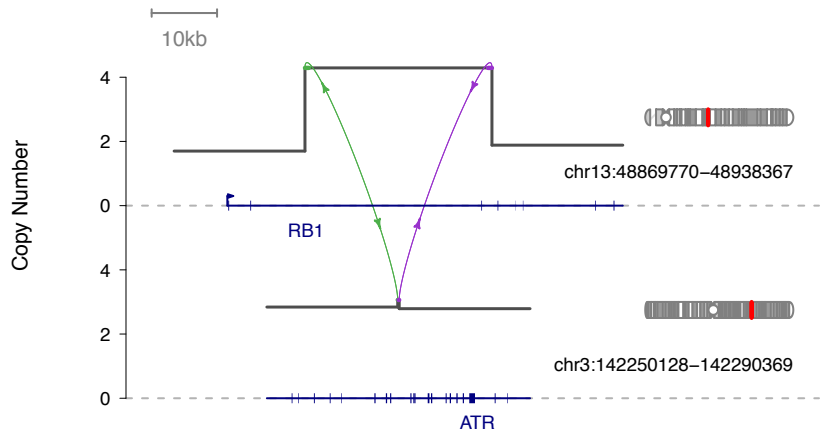

Ovary-AdenoCA SA518890 Ins Cycle

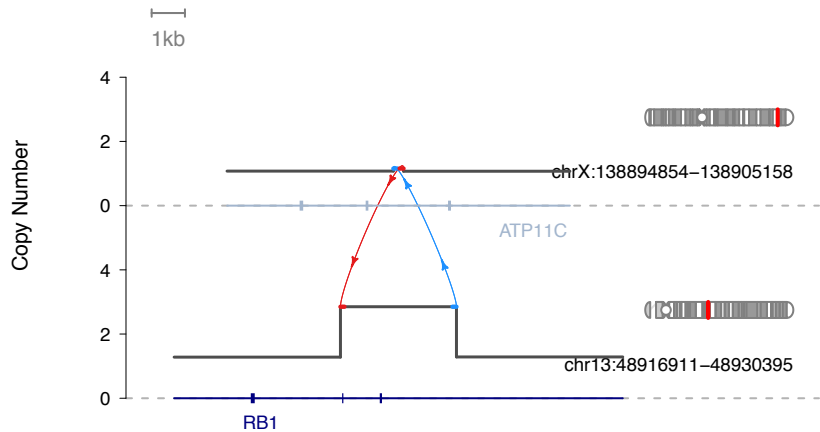

Breast-AdenoCA

