

1           **Neuronal constituents and putative interactions within the**  
2                           ***Drosophila* ellipsoid body neuropil**

3  
4    Jaison Jiro Omoto<sup>1,2a</sup>, Bao-Chau Minh Nguyen<sup>1a</sup>, Pratyush Kandimalla<sup>1</sup>, Jennifer Kelly Lovick<sup>1</sup>,  
5    Jeffrey Michael Donlea<sup>2</sup>, Volker Hartenstein<sup>1\*</sup>

6    <sup>1</sup>Department of Molecular, Cell and Developmental Biology, University of California, Los  
7    Angeles, Los Angeles, CA, USA.

8    <sup>2</sup>Department of Neurobiology, University of California, Los Angeles, Los Angeles, CA, USA.

9  
10  
11  
12    <sup>a</sup>Equal Contribution

13    \*Correspondence:

14    Dr. Volker Hartenstein

15    volkerh@mcdb.ucla.edu

16  
17  
18  
19  
20  
21  
22  
23  
24  
25  
26  
27    Manuscript Length: 11900 words

28    Main Figures: 10, Supplemental Figures: 2

29 **Abstract**

30 The central complex (CX) is a midline-situated collection of neuropil compartments in the  
31 arthropod central brain, implicated in higher-order processes such as goal-directed navigation.  
32 Here, we provide a systematic genetic-neuroanatomical analysis of the ellipsoid body (EB), a  
33 compartment which represents a major afferent portal of the *Drosophila* CX. The neuropil volume  
34 of the EB, along with its prominent input compartment, called the bulb, is subdivided into precisely  
35 tessellated domains, distinguishable based on intensity of the global marker DN-cadherin. EB  
36 tangential elements (so-called ring neurons), most of which are derived from the DALv2  
37 neuroblast lineage, interconnect the bulb and EB domains in a topographically-organized fashion.  
38 Using the DN-cadherin domains as a framework, we first characterized the bulb-EB connectivity  
39 by Gal4 driver lines expressed in different DALv2 ring neuron (R-neuron) subclasses. We  
40 identified 11 subclasses, 6 of which correspond to previously described projection patterns, and 5  
41 novel patterns. These subclasses both spatially (based on EB innervation pattern) and numerically  
42 (cell counts) summate to the total EB volume and R-neuron cell number, suggesting that our  
43 compilation of R-neuron subclasses approaches completion. EB columnar elements, as well as  
44 non-DALv2 derived extrinsic ring neurons (ExR-neurons), were also incorporated into this  
45 anatomical framework. Finally, we addressed the connectivity between R-neurons and their  
46 targets, using the anterograde trans-synaptic labeling method, *trans*-Tango. This study  
47 demonstrates putative interactions of R-neuron subclasses and reveals general principles of  
48 information flow within the EB network. Our work will facilitate the generation and testing of  
49 hypotheses regarding circuit interactions within the EB and the rest of the CX.

50

51

52

53

54

55

56

57

58

59

60

61

62

63

## 64 Introduction

65 The central complex (CX) is an evolutionarily conserved, higher-order neuropil in the  
66 arthropod brain thought to integrate sensory and motor information to coordinate and maintain  
67 locomotor behavior, thus enabling appropriate navigation. *Drosophila* mutations that produce  
68 structural abnormalities in CX neuropils result in flies with deficiencies in walking and flight  
69 (Martin et al., 1999; Strauss and Heisenberg, 1993). More targeted manipulations, such as  
70 silencing of specific CX neuron subclasses, compromise vision-based memories associated with  
71 spatial orientation and location (Neuser et al., 2008; Ofstad et al., 2011). Similar themes emerge  
72 from anatomical, electrophysiological, and behavioral studies investigating the CX in other  
73 insects. In the cockroach CX, for example, single unit activity correlated with changes in  
74 locomotor intensity, turning behavior, or heading direction have been identified (Bender et al.,  
75 2010; Guo and Ritzmann, 2013; Varga and Ritzmann, 2016). In addition, electrical stimulation of  
76 CX neurons in the freely walking cockroach has yielded direct evidence linking CX activity to  
77 downstream locomotor output (Martin et al., 2015). In other insects, such as locust, cricket,  
78 monarch butterfly, and dung beetle, neurons in the CX are tuned to celestial visual cues such as  
79 the sun or pattern of polarized skylight. These cues provide the stable environmental signals  
80 required to accurately derive relative heading information for short or long range navigations  
81 (Heinze and Homberg, 2007; Heinze and Reppert, 2011; Jundi et al., 2014; 2015).

82 The CX consists of four neuropil compartments: the upper (CBU) and lower (CBL) halves  
83 of the central body (CB), protocerebral bridge (PB), and paired noduli (NO) (Hanesch et al., 1989;  
84 Ito et al., 2014; Strausfeld, 2012). In *Drosophila*, the upper and lower halves of the central body  
85 are designated as the fan-shaped body (FB) and ellipsoid body (EB), respectively (Fig.1A). These  
86 neuropil compartments are formed by two orthogonally arranged neuronal populations: (1)  
87 columnar (small-field) neurons which interconnect the CX compartments along the antero-  
88 posterior axis; (2) tangential (large-field) neurons which provide input from lateral brain neuropils  
89 to the CX (Fig.1B, C). Terminal arborizations of these neurons define distinct vertical columns  
90 and horizontal layers that can be visualized by markers for synaptic or cell adhesion proteins that  
91 globally label, but exhibit variable density in, the neuropil. Based on Bruchpilot immunostaining,  
92 seven layers were identified in the *Drosophila* CBU (=FB; Fig.1A) (Wolff et al., 2015). The CBL  
93 (=EB) also exhibits a layered organization (Pfeiffer and Homberg, 2014). In *Drosophila*, this  
94 compartment undergoes a morphogenetic transformation during pupal development, whereby the  
95 lateral ends of the originally bar-shaped EB primordium bend ventrally to adopt a toroidal  
96 arrangement (Lovick et al., 2017; Xie et al., 2017; Young and Armstrong, 2010a; Fig.1A). As a  
97 result, tangential neurons of the EB display a circular shape, and hence were called “ring neurons”  
98 (Hanesch et al., 1989; Fig.1C). Likewise, layers within the EB are annuli, rather than horizontal  
99 slabs (Fig.1A). Based on labeling with DN-cadherin, we have defined five distinct annular  
100 domains, termed anterior (EBa), inner and outer central (EBic and EBoc), and inner and outer  
101 posterior (EBip and EBop) domains (Omoto et al., 2017; Fig.1D-G).

102 Clonal studies in *Drosophila* show that the neuronal architecture of the CX is organized  
103 into lineage-based modules (Ito and Awasaki, 2008; Yang et al., 2013), a ground plan that is likely  
104 conserved across insects (Boyan et al., 2017). A lineage refers to the set of sibling neurons derived  
105 from an individual neural progenitor called a neuroblast, and the entire central brain is generated  
106 from a fixed number of approximately 100 of such neuroblasts. Four lineages (DM1-4; Fig.1A)  
107 give rise to the large number of columnar neurons of the CX (Ito and Awasaki, 2008; Yang et al.,

108 2013). The great diversity observed among these neurons is achieved via temporal patterning of  
109 molecular determinants in dividing progenitors (Bayraktar and Doe, 2013; Doe, 2017; Wang et al.,  
110 2014). Lineages giving rise to the tangential neurons of the CX have been characterized  
111 morphologically (Ito et al., 2013; Larsen et al., 2009; Spindler and Hartenstein, 2010; Wong et al.,  
112 2013; Yang et al., 2013; Yu et al., 2013), but have not yet received much attention experimentally.  
113 The most notable exception is lineage DALv2/EBa1 (henceforth called DALv2), that generates  
114 ring neurons of the EB (Neuser et al., 2008; Omoto et al., 2017; Seelig and Jayaraman, 2013;  
115 Fig.1A). Ring neurons project their axons to distinct annular domains of the EB, and typically  
116 possess short globular dendrites (“microglomeruli”) in the bulb (BU), a neuropil compartment  
117 located laterally adjacent to the EB (Fig.1A). The bulb encompasses three main partitions (anterior,  
118 superior, inferior) that are associated with different annular domains of the EB (Fig.1A, E-G).  
119 Input to the bulb is provided by neurons of two additional lineages, DALcl1 and DALcl2 (also  
120 called AOTUv3 and AOTUv4, respectively) (Omoto et al., 2017; Wong et al., 2013; Yang et al.,  
121 2013; Yu et al., 2013). As part of the anterior visual pathway, DALcl1/2 form so-called tubercular-  
122 bulbar (TuBu) neurons which project from the anterior optic tubercle to the bulb, relaying visual  
123 information to ring neurons and thereby the CX as a whole. TuBu neurons form two lineally-  
124 segregated parallel channels, with DALcl1 establishing connections with ring neurons located in  
125 the peripheral domain of the EB via the superior bulb, and DALcl2 with central ring neurons via  
126 the inferior bulb (Omoto et al., 2017; Shiozaki and Kazama, 2017; Fig.1A).

127 Detailed functional studies are beginning to shed light on the circuitry involving ring  
128 neurons and their TuBu afferents and columnar efferents. Two-photon calcium imaging has  
129 revealed a discrete focus of neural activity, or “bump”, within a population of columnar neurons  
130 (“E-PGs”) that interconnect the EB, PB, and gall of the LAL. E-PG neurons encode an internal  
131 compass representation via the activity bump, which dynamically tracks the fly’s heading (Seelig  
132 and Jayaraman, 2015; Fig.1A). Additional columnar neuron populations that interconnect the PB,  
133 EB, and NO, called P-EN neurons, compute the animals’ heading by controlling the movement of  
134 the bump in the clockwise or counter-clockwise direction (Green et al., 2017; Turner-Evans et al.,  
135 2017). These findings suggest that the EB may operate as a critical hub in the CX, acting as an  
136 interface between neurons that transmit and distribute sensory information (TuBu and ring  
137 neurons), and circuits that encode and update a representation of heading direction (E-PG and P-  
138 EN neurons). In addition, internal state information is likely integrated into the EB network by  
139 additional ring neuron subclasses that signal physiological needs such as sleep and hunger drive  
140 (Dus et al., 2013; Liu et al., 2016; Park et al., 2016).

141 To make further inroads in understanding how the EB circuitry operates, a comprehensive  
142 knowledge of ring neurons and their upstream and downstream connectivity is required.  
143 Ultimately, a comprehensive analysis of single cells and their synaptic contacts on the light and  
144 electron microscopy level will yield complete coverage of the EB wiring diagram, and certainly  
145 inform our understanding of how EB-related computations are implemented (Zheng et al., 2018).  
146 However, a current description of subclass-specific projection patterns using genetic driver lines  
147 provides a framework to posit inter-class neural interactions that can then be tested physiologically  
148 and/or behaviorally, and will assist future efforts for such high-resolution anatomical maps. To  
149 this end, we sought to expand on previous works using this genetic-anatomical approach to more  
150 thoroughly describe the EB neuropil (Martín-Peña et al., 2014; Omoto et al., 2017; Renn et al.,  
151 1999; Young and Armstrong, 2010b). Gal4 driver lines that label ring neuron subclasses were  
152 screened and subsequently distinguished from each other based on defined criteria. Many drivers

153 label populations corresponding to previously identified ring neuron subclasses, in addition to  
154 several, yet uncharacterized populations. The novel subclasses were given new names per the  
155 historical nomenclature system. Columnar elements were also incorporated into this anatomical  
156 framework. Based on the domain innervation pattern of each line, putative interactions between  
157 elements within the EB network are proposed. Finally, ring neuron drivers were subjected to the  
158 anterograde trans-synaptic labeling method, *trans*-Tango (Talay et al., 2017). Ring neurons  
159 occupying central domains of the EB commonly display homotypic interactions, such that neurons  
160 of a given subclass predominantly form synaptic interactions with other neurons in the same  
161 subclass. On the other hand, ring neurons occupying the peripheral domains typically display a  
162 larger degree of output into the columnar network. This highlights a fundamental difference in the  
163 connectivity, and potentially the functions, of ring neurons in different domains.  
164

## 165 **Material and methods**

### 166 **Fly lines**

167 The following *Drosophila* Gal4 driver lines are from the Janelia Research Campus stock  
168 collection (Jenett et al., 2012), and acquired from the Bloomington *Drosophila* Stock Center  
169 (BDSC), Bloomington, Indiana: R31A12, R78B06, R80C07, R28E01, R28D01, R12G08,  
170 R35D04, R84H09, R15B07, R12B01, R59B10, R38H02, R78A01, R14G09. VT063949,  
171 VT057232, and VT011965 are Vienna Tile Gal4 driver lines (Tirian and Dickson, 2017) and were  
172 acquired from Dr. Barry Dickson. Ring neuron lines were typically identified by visually screening  
173 the Janelia FlyLight database (<http://flweb.janelia.org/cgi-bin/flew.cgi>). R14G09 was identified by  
174 first visually screening the Flycircuit database (<http://www.flycircuit.tw/>) for EB innervating  
175 neurons, yielding clone ID# VGlut-F-300355 (Chiang et al., 2011), followed by use of the  
176 NBLAST (Flycircuit to Gal4 query) search algorithm (Costa et al., 2016). Additional stocks, with  
177 citation and availability listed in parentheses: 189Y, c42, c232, c105, c507 (Renn et al., 1999;  
178 BDSC), EB1-Gal4 (Young and Armstrong, 2010b), Poxn-Gal4 (Boll and Noll, 2002; provided by  
179 Dr. H. Reichert), 10xUAS-mCD8::GFP (BDSC), TPH-Gal4 (Park et al., 2006; provided by Dr. M.  
180 Frye), TH-Gal4 (Friggi-Grelín et al., 2003; BDSC), UAS-DenMark::mCherry, UAS-syt.EGFP  
181 (Nicolai et al., 2010; BDSC), su(Hw)attP8:HA\_V5\_FLAG\_1 (Nern et al., 2015; BDSC), *trans*-  
182 Tango (Talay et al., 2017; provided by Dr. G Barnea).

### 183 **Clonal analysis**

184 Mosaic analysis with a repressible cell marker (MARCM) was conducted to generate heat  
185 shock inducible, single-cell clones of ring neurons (Lee and Luo, 1999). Flies of the following  
186 genotypes were utilized: hsflp/+ ; FRTG13, UAS-mCD8GFP/FRTG13, tub-GAL80 ; tub-Gal4/+  
187 or FRT19A, tub-GAL80, hsflp, UAS-mCD8GFP/elav<sup>C155</sup>-Gal4, FRT19A ; UAS-mCD8GFP/+.  
188 GFP-labeled adult single cell MARCM clones were induced at the late first instar/early second  
189 instar stage by heat-shocking in a water bath at 38 °C for 30-60 min. Larvae were collected after  
190 hatching, reared at 18 °C, and heat-shocked at different time intervals between 12-144 hours  
191 (double time; corresponding to roughly 6-72h at 25 °C). Heat-shocked larvae were grown to  
192 adulthood for subsequent dissection and analysis. Single-cell analysis of TH-Gal4 positive neurons  
193 was conducted using the multicolor flip-out method (MCFO) described previously (Nern et al.,  
194 2015; Wolff et al., 2015).

## 195 **Immunostaining**

196 3-8 day old female adults were used for all experiments; potential sexual dimorphism  
197 would be undetected in this study. Flies were grown at 25°C on standard fly media, in low density  
198 bottles on a 12hr:12hr light/dark schedule. Immunohistochemical procedures were conducted as  
199 follows, and are similar to those previously described (Omoto et al., 2017). Adult brains were  
200 dissected in phosphate buffered saline (PBS), pH 7.4. Brains were (1) fixed in ice-cold PBS  
201 containing 4% EM-grade paraformaldehyde for 2.5-3 hours; (2) washed 4X for 15 min each with  
202 ice-cold PBS; (3) subjected to cold ethanol-PBS dehydration (five minute washes in 5, 10, 20, 50,  
203 70, 100% EtOH); (4) stored in -20°C overnight; (5) rehydrated using the same cold EtOH series in  
204 reverse order; (6) washed 2X 15 min in cold PBS and 2X 15 min washes in cold 0.3% PBT (PBS  
205 containing 0.3% Triton X-100); (7) washed in room temperature (RT) 0.3% PBT 4X 15 min; (8)  
206 incubated in blocking buffer (10% normal goat serum in 0.3% PBT) for 30 min at RT; (9)  
207 incubated in primary antibody, diluted in blocking buffer, at 4°C for 3 nights; (10) washed 4X 15  
208 min in RT 0.3% PBT; (11) incubated with secondary antibody diluted in blocking buffer at 4°C  
209 for an additional 3 nights; (12) washed 4X 15 min in RT 0.3% PBT and mounted using Vectashield  
210 (Vector Laboratories). For 10xUAS-mCD8::GFP panels, native fluorescence of the reporter was  
211 used to visualize the neurons. To maximally detect both pre- and post-synaptic neurons in *trans-*  
212 Tango experiments, both anti-GFP and anti-DsRed were utilized.

213 The following antibodies were provided by the Developmental Studies Hybridoma Bank (Iowa  
214 City, IA): rat anti-DN-cadherin (DN-EX #8, 1:20), mouse anti-Neuroglian (BP104, 1:30). Chicken  
215 anti-GFP (Abcam #ab13970, 1:1000) and Rabbit anti-DsRed (Clontech #632496, 1:1000) were  
216 also used. We also used rabbit anti-HA (1:300, Cell Signaling Technologies), and mouse anti-V5  
217 (1:1000, Thermo Fisher Scientific).

218 Secondary antibodies, IgG<sub>1</sub> (Jackson ImmunoResearch; Molecular Probes) were used at the  
219 following dilutions: Cy5-conjugated anti-mouse (1:300), Cy3-conjugated anti-rat (1:300). Alexa  
220 We used 488-conjugated anti-chicken (1:1000), Alexa 546-conjugated anti-rabbit (1:1000),  
221 Alexa488-conjugated anti-mouse (1:1000) from Thermo Fisher Scientific. Cy5-conjugated anti-  
222 rat (1:300) and cy3-conjugated anti-rabbit (1:300) from Abcam were also used.

## 223 **Confocal microscopy and image analysis**

224 Samples were mounted primarily in the antero-posterior (A-P) or dorso-ventral (D-V)  
225 orientation, and in some cases the postero-anterior (P-A) orientation. D-V orientation required  
226 constructing a crevice using two closely neighboring pieces of tape followed by two cover slips,  
227 into which the brain can be inserted dorsal-side up. Whole-mounted brains were imaged using  
228 confocal microscopy [LSM 700 Imager M2 using Zen 2009 (Carl Zeiss Inc.)]. Series of optical  
229 sections were imaged using a 40X oil lens with a numerical aperture of 1.3, a zoom factor of 1.0,  
230 at 1.2- $\mu$ m intervals, and 1024 x 1024 pixel resolution. Digitized images of confocal sections were  
231 processed in FIJI (Schindelin et al., 2012; <http://fiji.sc/>). The ellipsoid body, relative to the rest of  
232 the brain, exhibits a tilt on its frontal axis such that the ventral half is oriented anteriorly. We  
233 established standard, reproducible views of the EB in both the frontal and horizontal planes (used  
234 in all figures) by digitally tilting the z-stack using the “Interactive Stack Rotation” plugin  
235 ([http://imagej.net/Interactive\\_Stack\\_Rotation](http://imagej.net/Interactive_Stack_Rotation)). Antero-posteriorly and dorso-ventrally mounted  
236 preparations were digitally tilted such that the canal of the ellipsoid body was oriented parallel and  
237 perpendicular to the z-axis, respectively. In several cases, particularly in cases for z-projections

238 that span large depths (greater than  $\sim 75 \mu\text{M}$ ; ex. dorsal *trans*-Tango images), background labeling  
239 was manually removed in FIJI to improve visualization of entire neuronal ensembles. Cell counts  
240 were conducted manually using the FIJI “Cell Counter” plugin  
241 (<https://imagej.nih.gov/ij/plugins/cell-counter.html>). Cell body clusters on both sides of each brain  
242 were counted for at least three samples per driver line. Mean and standard error of the mean was  
243 calculated. Schematics were generated in Adobe Illustrator and figures constructed in Adobe  
244 Photoshop. Videos were compiled using Camtasia 9.1 with annotations on individual slices made  
245 using FIJI “Dotted Line” plugin (<https://imagej.nih.gov/ij/plugins/dotted-line.html>).

## 246 **Results**

### 247 **Classification of EB ring neurons: criteria and general considerations**

248 Using Golgi staining to characterize individual CX neuron types in *Drosophila*, the term  
249 “ring neuron” was coined by Hanesch et al., (1989), defined as “large-field neurons forming ring-  
250 like arborizations around the ellipsoid body canal”. Although “R-neuron” is commonly used as a  
251 synonymous abbreviation for “ring neuron”, the latter (full) term was originally used by Hanesch  
252 et al., (1989) as an umbrella designation for two major neuron types, R and ExR (“extrinsic ring  
253 neurons”). R-neurons represent the most abundant type, with cell bodies located in the anterior  
254 cell body rind (also called cortex herein), dorso-laterally of the antennal lobes. ExR-neurons were  
255 defined as ring neurons that have “extensive arborizations outside of the EB”. Due to the utility of  
256 this distinction to refer to ring neurons derived from distinct neuroblast lineages (DALv2 = R-  
257 neurons; DM4-6 and BAMv1 = ExR-neurons), we re-adopt it for this study (see below).

258 For the time being, we adopt and expand upon the historical *Drosophila* ring neuron  
259 nomenclature system (i.e. R1, R2, ExR1, etc.), initially introduced by Hanesch et al., (1989) with  
260 other studies largely following suit (Omoto et al., 2017; Renn et al., 1999; Young and Armstrong,  
261 2010b). Wolff et al., (2015) developed a formal nomenclature system for neuron types of the PB,  
262 in which each cell type was named based on a unique, descriptive collection of identifiers. As more  
263 information becomes available, adopting a unified nomenclature system in conjunction with  
264 subordinate colloquial terminology, for ring neurons and other neurons comprising the rest of the  
265 CX or brain in general, may be most suitable. We propose that this prospective system would  
266 ideally incorporate lineage classification as one of these identifiers, as the fly brain is inherently  
267 organized into structurally and developmentally-defined clonal units.

268 In most cases, the Gal4 drivers that label the ring neurons described in this study were  
269 visually screened from the Janelia (Jenett et al., 2012) or Vienna Tiles (Tirian and Dickson, 2017)  
270 collections and subsequently stained with the global neuropil marker DN-cadherin. Drivers were  
271 classified as labeling a unique ring neuron subclass based on the following criteria: 1) the EB DN-  
272 cadherin subdomain occupied by the circular, predominantly axonal, arbors, 2) the trajectory and  
273 morphology of said projections, and 3) the location of their presumed dendritic proximal neurites,  
274 typically microglomeruli in the bulb or fibrous neurites in the lateral accessory lobe (LAL).

275 Altogether, we identified fifteen unique ring neuron subclasses: eleven R-neuron and four  
276 ExR-neuron subclasses. This expands the catalog from six R-neuron (R1, R2, R3, R4m, R4d, R5)  
277 and two ExR-neuron (ExR1 and ExR2) subclasses, from previous reports (Hanesch et al., 1989;  
278 Omoto et al., 2017; Renn et al., 1999; Young and Armstrong, 2010b). However, it is critical to  
279 note a caveat of this study: each driver labels a population of neurons which were not anatomically

280 evaluated on a single-cell basis, as has been done for the neurons innervating the PB (Wolff et al.,  
281 2015). Indeed, multicolor-flip out analysis (MCFO) of some ring neuron drivers from this study  
282 yielded qualitatively distinct anatomical subtypes, even within a superficially homogenous  
283 population (data not shown). Therefore, although this study significantly expands upon the cohort  
284 of known ring neuron subclasses, in the absence of higher-resolution methods (single-cell light  
285 microscopy, TEM reconstructions) and supplementary genetic/physiological evidence, the precise  
286 diversity of ring neuron subclasses is still underestimated. Nonetheless, this study provides a more  
287 complete catalog and explicit criteria with which ring neuron subclasses can be anatomically  
288 defined. These criteria may be used as a framework to define new subclasses identified in  
289 subsequent studies.

290 One supplementary objective of this study is to resolve discrepancies in the literature  
291 regarding ring neuron subclasses, a consequence of somewhat undefined criteria and lack of spatial  
292 resolution. We have reevaluated previously published driver lines based on the proposed criteria  
293 and have found that oftentimes, a given ring neuron subclass has been called distinct names in  
294 different studies. Alternatively, a previously unidentified subclass has been assumed to be one of  
295 the preexisting subclasses because it appeared similar. When examining each subclass below, we  
296 will refer to pertinent examples of this, and provide data to reevaluate these comparisons based on  
297 our criteria.

## 298 **R-neurons: lineage DALv2/EBa1**

299 The most abundant ring neuron type is the R-neurons, whose cell bodies are located dorso-  
300 laterally of the antennal lobes and exhibit projections that extend dorso-posteriorly, branching off  
301 localized neurites into the bulb (BU) or LAL, enter the lateral ellipsoid fascicle [(LE; Lovick et  
302 al., 2013; Peraanu et al., 2010; Strausfeld, 2012); also called the "isthmus tract" (Ito et al., 2014)],  
303 and via a circular process, terminates medially into the EB (Figs.2 and 3). In the EB, distal neurites  
304 of R-neurons either project centrifugally ("inside-out"; Fig.2) or centripetally ("outside-in"; Fig.3).  
305 Clonal analysis of fly brain lineages revealed a single paired type I neuroblast that generates R-  
306 neurons called DALv2 (Omoto et al., 2017; Wong et al., 2013), also called EBa1 (Ito et al., 2013;  
307 Yu et al., 2013). The driver Poxn-Gal4 (Boll and Noll, 2002; data not shown), which labels the  
308 majority of (but possibly not all) DALv2 R-neurons, can, at first approximation, be used to estimate  
309 the total number of R-neurons. Quantification of these cells reveals  $158 \pm 9$  R-neurons per brain  
310 hemisphere (PBH). Despite the aforementioned caveats, the following catalog of R-neuron drivers  
311 is likely close to comprehensive, considering that summation of the neurons from each R-neuron  
312 driver (11 lines) totals  $\sim 176$  cells PBH (see below). In the following sections, we summarize the  
313 neuroanatomy of Gal4 lines that label unique R-neuron patterns.

### 314 **R1:**

315 R1 neurons (Renn et al., 1999), here labeled by the driver 31A12-Gal4 (Fig.2A; Supp.  
316 Movie 1 and 2;  $13 \pm 2$  neurons PBH), are among the minority of R-neurons that do not form  
317 glomerular dendritic branches in the bulb, but instead connect to the adjacent LAL. Here, terminal  
318 branches form a tuft of fine fibers spreading along the lateral surface of the LAL, ventrally and  
319 posteriorly adjacent to the gall (GA; Fig.2A1-A4). Distal fibers of R1 continue medially along the  
320 LE, curve around the anterior surface of the EB and, after entering the central canal, project  
321 posteriorly. Terminal distal branches densely fill a narrow volume within the outer posterior  
322 domain of the EB (EBop) which lines the boundary between EBop and the inner posterior domain  
323 (EBip) (Fig.2A5-A6). The identical pattern is labeled by c105 (Renn et al., 1999; Supp. Fig.1A).



324 The expression of constructs that are specifically targeted towards the dendritic and axonal  
325 compartments of neurons (UAS-DenMark, UAS-syt.EGFP; Nicolai et al., 2010) suggest that  
326 proximal projections to the LAL are exclusively postsynaptic/dendritic, and distal ones terminating  
327 in the EB are predominantly axonal (Supp. Fig.2).

### 328 **R2:**

329 R2 neurons, defined by Hanesch et al. (1989) are labeled here by 78B06-Gal4 (Fig.2B;  
330 Supp. Movie 3 and 4,  $23 \pm 2$  neurons PBH). Other drivers predominantly labeling this subclass are  
331 c42 (Supp. Fig.1B), introduced by Renn et al. (1999), and EB-1 (Seelig and Jayaraman, 2013;  
332 Thran et al., 2013; Young and Armstrong, 2010b; Supp. Fig.1C). R2 comprises outer R-neurons  
333 with distal, axonal endings branching throughout most of the outer central domain of the EB  
334 (EBoc; Fig.2B1, B5, B6). Only a narrow fringe along the periphery of EBoc is devoid of R2  
335 terminals (Fig.2B5; arrow). This fringe is innervated by R4d (see below). R2 axons reach their  
336 destination by following the LE around the anterior surface of the EB, entering the central canal  
337 and then projecting centrifugally towards EBoc (Fig.2B5, B6). By this criterion they differ from  
338 the outer ring neuron subclass R4m, which projects to the same domain, but reaches it in a  
339 centripetal fashion (see below). Proximal dendrites of R2 form club-shaped glomerular endings in  
340 the medial two-thirds of the superior bulb (Fig.2B3, B4).

### 341 **R3 (distal, medial, anterior, posterior, wide):**

342 The former R3 subclass of inner ring neurons can be broken up into at least five subclasses,  
343 R3d, R3m, R3a, R3p, R3w, defined by their axonal projections to distinct regions within the inner  
344 central (EBic) and inner posterior (EBip) domains of the EB. R3d neurons, marked by the driver  
345 80C07-Gal4 (Fig.2C; Supp. Movie 5 and 6,  $36 \pm 1$  neurons PBH), project along the LE towards the  
346 anterior EB surface, turn posteriorly into the central canal and from there spread centrifugally  
347 throughout EBic (Fig.2C5, C6). They spare a small medial and anterior portion of EBic, which are  
348 innervated in a partially overlapping fashion by the subclasses R3m (Fig.2D5-D6; Supp. Movie 7  
349 and 8,  $21 \pm 1$  neurons PBH) and R3a (Fig.2E5-E6; Supp. Movie 9 and 10,  $11 \pm 0$  neurons PBH),  
350 respectively. Microglomerular dendritic endings of R3d fill the posterior region of the inferior bulb  
351 (pBUi; Fig.2C4). A few additional microglomeruli are observed in the dorso-medial part of the  
352 anterior region of the inferior bulb (aBUi), leaving the rest of aBUi empty (Fig.2C3). Dendritic  
353 projections of R3m [marked by 28E01-Gal4 in Fig.2D, and 28D01-Gal4 (Supp. Fig.1D; referred  
354 to as "R1" in Ofstad et al., 2011)] and R3a (12G08-Gal4; Fig.2E) differ from that of R3d: R3m  
355 dendrites are relatively confined to aBUi (Fig.2D3), and R3a may send very few, fibrous dendrites  
356 to aBUi, directing most of its dendrites to a small region near the dorso-lateral surface of the LAL,  
357 ventro-medially adjacent to the anterior bulb (BUa; Fig.2E1-E3). This "aberrant" dendritic  
358 projection (no glomerular synapses; targeting areas outside the bulb) puts R3a in close proximity  
359 to R1 (see above). However, the LAL territory innervated by R1 appears larger, and is located  
360 more postero-medially, than the one targeted by R3a (compare Figs.2A1-A4 and 2E1-E4).

361 The inner ring neuron subclass R3p, marked by VT063949-Gal4 (Fig.2F; Supp. Movie 11  
362 and 12,  $9 \pm 0$  neurons PBH), has axonal projections predominantly restricted to the inner posterior  
363 domain (EBip) of the EB, largely non-overlapping with the projection of R3d/m/a (Fig.2F5-F6).  
364 Some small projections extend anteriorly, encroaching on EBic (Fig.2F6; arrow). Dendritic  
365 branches comprise a main conglomerate of endings located in the dorsal part of pBUi (Fig.2F4), a  
366 region not occupied by dendritic endings of R3d (compare to Fig.2C4).

367 Finally, the arborization pattern of ring neurons called R3w, marked by VT057232-Gal4  
368 (Fig.2G; Supp. Movie 13 and 14,  $27\pm 2$  neurons PBH), comes closest to that of the neuron subclass  
369 originally designated “R3” by Hanesch et al. (1989). Like all other R3 neurons listed above, R3w  
370 neurons project axons past the anterior surface of the EB into the canal, from where they spread  
371 centrifugally (Fig.2G1, G5-G6). However, terminal branches are given off centrally, near the  
372 boundary between EBic and EBip, as well as more peripherally, in the inner part of EBoc  
373 (Fig.2G5-G6). Glomerular dendritic endings occupy a medial region within the superior bulb  
374 (BUs; Fig.2G3-G4)

375 Driver lines expressed in inner ring neurons (“R3”) described previously may represent  
376 composites marking two or more different neuron subclasses. For example, 189y (Renn et al.,  
377 1999; Supp. Fig.1E) and 84H09 (Omoto et al., 2017; Supp. Fig.1F) include dendritic and axonal  
378 territories of R3d and R3p, targeting EBic and EBip, and much of BU<sub>i</sub>, including the dorsal  
379 territory labeled by the R3p. It is also possible that presumably composite lines 189y and 84H09-  
380 Gal4 may mark a distinct subclass of ring neurons that individually branch in both domains, which  
381 we provisionally refer to as R3c\* (central). c232 and c507 (Renn et al., 1999; Supp. Fig.1G and  
382 H), as well as 15B07-Gal4 (Ofstad et al., 2011; Supp. Fig.1I) may represent a composite of R3d,  
383 R3p, and R4d, targeting EBic and EBip. The peripheral outer fringe, labeled by R4d (see below),  
384 is also present. Accordingly, most of BU<sub>i</sub> (including the dorsal R3p-associated region) and the  
385 lateral part of BUs (characteristic of R4d) are labeled by c232, c507, and 15B07-Gal4.  
386 Alternatively, these lines may represent composites of R3c\* and R4d.

#### 387 **R4 (distal and medial):**

388 Two subclasses of outer ring neurons already described in the existing literature are R4d  
389 and R4m. Axons of R4d (Renn et al., 1999), here specifically labeled by 12B01-Gal4 (Fig.3A;  
390 Supp. Movie 15 and 16,  $8\pm 0$  neurons PBH), reach the periphery of the EB from where they  
391 centripetally project very short terminal tufts into the fringe of EBoc. Dendritic branches form  
392 glomerular synapses confined to the lateral part of BUs (Fig.3A3-A4). R4m (Renn et al., 1999;  
393 here labeled by 59B10-Gal4) has similar axonal projections that penetrate the EB in a centripetal  
394 fashion. However, tufts of terminal branches are longer, filling the entire EBoc (Fig.3B5-B6; Supp.  
395 Movie 17 and 18,  $11\pm 3$  neurons PBH) The restricted dendritic projection into BU<sub>a</sub> is highly  
396 characteristic of R4m (Fig.3B2).

#### 397 **R5:**

398 In a previous paper (Omoto et al., 2017) we described an additional subclass of outer ring  
399 neurons called R5, labeled by 58H05-Gal4, which specifically targets the small, anterior EB  
400 domain (EB<sub>a</sub>; Fig.3C; Supp. Movie 19 and 20,  $14\pm 1$  neurons PBH). Axons of R5 behave like those  
401 of other outer ring neuron subclasses, approaching the antero-lateral surface of the EB, and  
402 projecting short terminal branches centripetally into EB<sub>a</sub> (Fig.3C5-C6). Dendritic terminals are  
403 confined to BUs, like those of the other outer ring neuron subclasses (R2 and R4d), but occupy a  
404 small distinct locus located ventro-medially (Fig.3C3-C4). The driver 38H02-Gal4 has been  
405 described in previous works as a subset of R4 neurons (Dus et al., 2013; Ofstad et al., 2011; Park  
406 et al., 2016), but reflects a composite marker of R5 in addition to R4m (Supp. Fig.1J), with axonal  
407 projection into EBoc and EB<sub>a</sub> (Supp. Fig.1J1-J3), and dendritic endings in BU<sub>a</sub> and the ventro-  
408 medial part of BUs (Supp. Fig.1J4-J6). R5 has been referred to as “R2” or an “R2 subset” in  
409 previous works (Lin et al., 2013), particularly in the field of sleep regulation (Donlea et al., 2018;

410 Liu et al., 2016), but is distinct from R2 as defined in classical works and herein (Hanesch et al.,  
411 1989; Renn et al., 1999).

#### 412 **R6:**

413 We identified driver line VT011965-Gal4 as being expressed in a small number of DALv2  
414 R-neurons, a subclass we refer to as R6 (Fig.3D; Supp. Movie 21 and 22, 2±0 neurons PBH).  
415 Distal neurites of these neurons approach the EB peripherally (centripetal projection) and form a  
416 sparse mesh along the posterior and postero-lateral boundary of EBop (Fig.3D1, D5-D6). They  
417 also display short branches that extend anteriorly into EBop (Fig.3D6). Proximal neurites have a  
418 unique projection pattern, first forming dense branches within the gall (GA), and then continuing  
419 into the BU, where they show a web-like innervation reaching throughout BUa, BUi, and BU  
420 (Fig.3D2-D4).

421 We hypothesized that the different DALv2 subclasses are sublineages, consisting of  
422 neurons born at different time points. To address this hypothesis, we induced MARCM clones  
423 (Lee and Luo, 1999) using a pan-neuronal driver (tub-Gal4 or *elav*<sup>C155</sup>-Gal4) at defined  
424 developmental stages between 20-144h (reared at 18 °C) after hatching. Depending on where in  
425 the lineage the recombination event occurs, three types of clones [multi-cell or two-cell neuroblast  
426 clone, one-cell ganglion mother cell (GMC) clone] appear (Fig.4A). In a collection of GMC clones  
427 we found that early clone induction (20-48h) produced exclusively R4m ring neurons (Fig.4B, C).  
428 By contrast, induction at 48-72h and 72-96h resulted in a small fraction of R4m clones  
429 (approximately 20% at 48-72h, and 10% at 72-96h). Instead, we predominantly find R5, R4d, and  
430 R3 neurons (Fig.4B, D). R3 neurons subclasses are never seen in early clones (20-48h), and form  
431 the only type of clone induced at later time stages (96-144h; Fig.3B, E); 60% of the clones  
432 produced at intermediate time points belong to the R3 subclasses. These data indicate that  
433 birthdates of ring neurons differ systematically, and suggest that anatomically defined subclasses  
434 of R-neurons are indeed sublineages of DALv2.

#### 435 **Posterior ExR-neurons: lineages DM4-DM6**

436 Aside from the above described DALv2 neurons, we also observe an additional type of  
437 ring neurons. Given their widespread arborization outside the ellipsoid body, we classify them as  
438 extrinsic ring neurons (ExR), in accordance with Hanesch et al. (1989) who introduced this  
439 distinction. At least three subclasses of ExR-neurons with cell bodies located in the posterior  
440 brain cortex were recognized, and we refer to this group as the posterior ExR-neurons. Based on  
441 soma location and axonal projection these cells form part of the type II lineages CM4, CM3, and  
442 CM1, commonly known as DM4-6. Thus, all posterior ExR-neurons share a characteristic  
443 projection along the medial equatorial fascicle (MEF), which carries long axons from the  
444 posterior cortex to the LAL, extending medially of, and parallel to, the peduncle (Ito et al., 2014;  
445 Peraanu et al., 2010; Fig.5A, I, M). Fibers of large subsets of neurons belonging to lineages CM1  
446 (DM6), CM3 (DM5), and CM4 (DM4) make up the bulk of the MEF (Ito et al., 2013; Lovick et  
447 al., 2013; Peraanu and Hartenstein, 2006; Wong et al., 2013; Yu et al., 2013).

#### 448 **ExR1:**

449 The first subclass of ExR-neurons has been dubbed recently as "helicon cells" (Donlea et  
450 al., 2018), and can be visualized by the driver line 78A01-Gal4. Projecting anteriorly along the  
451 MEF, helicon axons reach the bulb and form ultra-dense arborizations in all domains of this

452 compartment (Fig.5C). Three fiber bundles continue from the bulb towards the FB, EB, and GA  
453 of the LAL, respectively. The fiber bundle towards the FB exits BUs in the dorso-medial direction  
454 and fans out into a plexus of terminal fibers that spread along the anterior edge of the FB roof  
455 (layer 8 after Wolff et al., 2015; Fig.5D-E). The fiber bundle destined for the EB follows the LE  
456 medially. Terminal fibers form a fine web surrounding the surface of the EB. In addition, endings  
457 are concentrated in EBa and EBic (Fig.5C, E). A third contingent of fibers projects from BUa  
458 towards antero-laterally and densely innervates the GA of the LAL (Fig.5B). Based on the striking  
459 morphological similarity, helicon cells likely correspond to the first type of extrinsic R-neuron  
460 (ExR1) as defined in Hanesch et al., (1989) (Fig. 21A in Hanesch et al., 1989; Fig.12B in Young  
461 and Armstrong, 2010b; Fig. 4A in Donlea et al., 2018). Based on their cell body position and  
462 projection along the MEF, ExR1 can be attributed to the lineages DM4-DM6, but cannot be  
463 assigned to a specific lineage in the absence of further clonal analysis.

#### 464 **ExR2:**

465 The PPM3 group of dopaminergic neurons described in previous works encompasses the  
466 next subclass of posterior ExR-neurons (Fig.5F-I, N-Q), and can be visualized by TH-Gal4 (Friggi-  
467 Grelin et al., 2003). PPM3 is comprised of 8-9 cells whose bundled axons project anteriorly along  
468 the MEF, and form part of lineages DM4 and/or DM6 (Hartenstein et al., 2017; Ren et al., 2016).  
469 Reaching the level of the FB, PPM3 neurons branch out and innervate different compartments  
470 within the central complex (CX) and adjacent neuropils, including the bulb (BU) and lateral  
471 surface of the LAL, the anterior inferior protocerebrum [also called crepine (CRE); Ito et al., 2014],  
472 and the superior medial protocerebrum (SMP; Hartenstein et al., 2017; Fig.5F-I). Single cell clones  
473 revealed at least three different types:

474 (1) PPM3 neurons innervating the EB, BU, and lateral surface of the LAL (including the GA;  
475 Fig.5N; called PPM3-EB in the following). The PPM3-EB axon projects along the LE and enters  
476 EB at a dorso-lateral position (Fig.5O). Terminal arborizations are concentrated in EBop (Fig.5Q).  
477 Additional branches reach superior and inferior parts of both ipsi- and contralateral bulbs (Fig.5O).  
478 Note that within the BU, unlike most DALv2 ring neurons (see Figs.2 and 3) or the afferent TuBu  
479 neurons (Omoto et al., 2017), terminal PPM3-EB branches do not end in large microglomerular  
480 structures, but form thin, highly branched endings. Due to its EB innervation, we refer to these  
481 neurons as the ExR2 subclass. Like PPM3-EB, ExR2 as defined by Hanesch et al., (1989) also  
482 contains a caudal innervation pattern in the EB, but a direct correspondence cannot be made since  
483 the cell from this study was not fully reconstructed and the ring neuron from lineage BAMv1 also  
484 innervates the same EB region (see below).

485 (2) At least two subtly different kinds of PPM3 neurons innervating FB, NO, LAL, CRE, and SMP  
486 exist, one of them shown in Fig.5N-Q (magenta; PPM3-FB). This cell arborizes in the ventral  
487 layers (2-3, after Wolff et al., 2015) of the FB, and the intermediate noduli (NO2). Separate  
488 branches project to the lateral surface of the LAL, where projections partially overlap with those  
489 of PPM3-EB (green; Fig.5O), but stay out of the GA and instead reach the medially adjacent CRE  
490 (Fig.5N, O). A third branch projects upward into a discrete subdomain of the SMP (Fig.5O, P).

491 (3) A third type of PPM3 neuron (PPM3-LAL; not shown) does not innervate the EB or FB, but  
492 has bilateral projections to the lateral surface of the LAL. The second and third type of PPM3  
493 neurons are not considered ExR-neurons due to their lack of EB innervation.

494 **ExR3:**

495 A subset of serotonergic neurons, visualized by the driver TPH-Gal4 (Park et al., 2006),  
496 also form part of the type II lineages, DM4-6, and have widespread projections towards the CX,  
497 BU, LAL, and CRE (Fig.5J-M). Single cell labeling to resolve cell types with different projections  
498 within the CX have not been carried out. A plexus of thin fibers enters the EB from laterally via  
499 the LE. Within the EB, terminal arborizations are largely non- overlapping with those of  
500 dopaminergic PPM3-EB (see below), showing highest density in EBic (Fig.5M). The serotonergic  
501 neuron subclass that innervates this domain is designated herein as ExR3 and is derived from  
502 DM4-6, but like ExR1, cannot be assigned to a specific lineage. Additionally, in the FB, one can  
503 distinguish innervation of a ventral stratum (layers 3-4 of Wolff et al., 2015) from that of a dorsal  
504 stratum (layers 6/7).

505 **Anterior ExR-neurons: lineage BAMv1/LALv1**

506 One additional subclass of ExR-neurons, designated as ExR4, was identified. Cell bodies  
507 of these neurons form a cluster in the anterior brain cortex, but, in contrast to DALv2 R-neurons,  
508 are located ventrally of the antennal lobe (Fig.6). ExR4 neurons, labeled by the driver 14G09-Gal4  
509 (Fig.6; Supp. Movie 23 and 24), belong to the lineage BAMv1 (Lovick et al., 2013; Wong et al.,  
510 2013), also called LALv1 (Ito et al., 2013; Yu et al., 2013).

511 ExR4 axons follow a highly characteristic pathway that initially leads posteriorly as part  
512 of the longitudinal ventro-medial fascicle (loVM) and then makes a sharp turn dorsally (Fig.6A,  
513 B). The dorsal leg of the BAMv1 tract penetrates the LAL and gives off dense tufts of branches  
514 that fill the dorso-lateral quadrant of the LAL compartment (Fig.6B, E). Some branches reach  
515 forward into the GA of the LAL (Fig.6B, D); others continue further dorsal into the CRE  
516 compartment (Fig.6B-D). Reaching the dorsal edge of the LAL, the axon tract of BAMv1 makes  
517 a second sharp turn, projecting medially towards the CX as the posterior part of the lateral ellipsoid  
518 fascicle (LEp). Axons reach the CX at the cleft between the EB and FB, and from there project  
519 anteriorly into EBop (Fig.6A, B, G) and posteriorly towards the ventral strata (1-4, after Wolff et  
520 al., 2015) of the FB and into NO2 (Fig.6A, B, F).

521 The structure of individual ExR-neurons of the BAMv1 lineage have not been thus far  
522 described in the literature. We identified a single cell clone in the FlyCircuit database (Chiang et  
523 al., 2011) that, based on axonal trajectory (loVM, LEp, EB), represents BAMv1 (Fig.6C). Notably,  
524 this neuron has profuse branches in the LAL (including the GA) and in the posterior EB, but does  
525 not project to the FB or NO, indicating that different neuron types of the BAMv1 lineage innervate  
526 the EB and the FB/NO, respectively.

527 DenMark and syt.EGFP expression revealed that projections of BAMv1 neurons towards  
528 the EB and FB/NO are mainly axonal, with only a weak dendritic component; proximal  
529 arborizations in the LAL are preferentially dendritic (Fig.6I-J'). Only the gall of the LAL has a  
530 significant axonal component (Fig.6H). This distribution of pre- and postsynaptic elements  
531 suggests that ExR-neurons of BAMv1 form a feed-back component connecting input and output  
532 domains within the CX circuitry: DALv2 ring neurons provide strong input to the EB, which is  
533 then transmitted to the FB and the GA/LAL by columnar neurons. BAMv1 neurons form dendritic  
534 endings in the GA/LAL and feedback axons towards the EB.

## 535 Columnar neurons

536 While ring neurons terminate in the EB, further processing of visual input requires synaptic  
537 partners that access other compartments of the CX. Several populations of columnar neurons  
538 fulfilling this requirement have been identified to date (Wolff et al., 2015). To investigate the  
539 spatial relationship of columnar neurons with ring neurons, we screened Gal4 drivers and  
540 identified lines with distinct columnar expression patterns (Fig.7). In this study, we anatomically  
541 assess four of such populations. These are two populations of “wedge neurons” with arborizations  
542 in both peripheral and central parts of the EB, and two populations of “tile” neurons that project  
543 only to the peripheral EB. Shown in Fig.7A is the first type of “wedge” neuron ( $PB_{G1-8}.b-EBw.s-$   
544  $D/Vgall.b$ ), also called E-PG neurons (Turner-Evans et al., 2017; Wolff et al., 2015), whose spiny  
545 (dendritic) terminal branches fill all EB domains except for much of EBa (Fig.7A1-A2).  
546 Confirming previous descriptions, bulbar (axonal) endings are seen in the PB, as well as the GA  
547 (Fig.7A1, A3, A6).

548 The second type of “wedge” neuron described to date ( $EBw.AMP.s-Dga.s.b$ ; Wolff et al.,  
549 2015) has dendritic endings confined to the EB and axonal projections to a region adjacent to the  
550 dorsal gall, called the dorsal gall surround (Dga-s). For brevity, we provisionally refer to this  
551 neuronal population as “E-G” neurons. In the EB, terminal arbors fill all domains, including EBa.  
552 Driver line 93G12-Gal4 (Fig.7B) is likely to include this neuron type, given strong label of the  
553 entire EB (including EBa) and the Dga-s. However, other neuron populations are marked as well,  
554 including, most likely,  $PB_{G1-8}.s-FBI3,4,5.s.b-rub.b$  (provisionally “PF-FR”) neurons [label in the  
555 PB, FB, and rubus (RU) domain of the CRE] and E-PG neurons (label in the PB and ventral GA)  
556 (Wolff et al., 2015; Fig.7B).

557 The list of columnar neurons described in the literature is likely to be incomplete, given  
558 that the comprehensive overview of Wolff et al. (2015) focused primarily on neurons with  
559 connections to the PB. Another such cell type, not yet described, is included in the population of  
560 neurons labeled by 89E04-Gal4 (Fig.7C). Enriched signal is seen in EBip and EBa (Fig.7C1, C2;  
561 arrows), a pattern not shown by E-PG neurons or P-EN neurons. Presumed endings of this cell  
562 type form dense glomerular structures in the CRE (Fig.7C1, C2, C6) and the Dga-s. As the  
563 compartments which contain dendritic components of these neurons cannot be precisely resolved,  
564 we provisionally refer to them as “X-CRE” neurons. PF-FR neurons are likely marked by 89E04-  
565 Gal4 as well, given the label in these compartments (Fig.7C3, C4, C6).

566 Fig.7D, E show the projection pattern of P-EN neurons ( $PB_{G2-9}.s-EBt.b-NO1.b$ ; Turner-  
567 Evans et al., 2017; Wolff et al., 2015). This neuronal population has axonal endings in a tile-  
568 shaped domain, which we show here corresponds to EBop (Fig.7D2, D5, E2, E5). Outside the EB,  
569 projections are in the PB (Fig.7D3, E3) and the dorsal noduli (NO1; Fig.7D4, E4). Functionally,  
570 P-EN neurons fall into two subclasses, one (called P-EN1; Green et al., 2017; Turner-Evans et al.,  
571 2017) marked by the driver 37F06-Gal4 (Fig.7D), and the other one (P-EN2; Green et al., 2017)  
572 by 12D09-Gal4 (Fig.7E). In regard to terminal arborization in the EB, both lines appear identical  
573 (compare Fig.7D2, E2). However, 37F06-Gal4 is likely expressed in an additional neuron type  
574 called  $PB_{G2-9}.s-FBI3.b-NO2V.b$  (provisionally “P-F<sub>3</sub>N<sub>2</sub>”; subscripts denote which  
575 subcompartment of the FB or NO is innervated), given labeling in the FB and NO2 (Wolff et al.,  
576 2015; Fig.7D4).

577

## 578 Mapping the putative postsynaptic targets of R-neurons

579 To identify downstream postsynaptic targets of distinct R-neuron subclasses, we utilized  
580 the anterograde trans-synaptic tracing method *trans*-Tango (Talay et al., 2017). In this approach,  
581 a bioengineered synthetic receptor system and downstream signaling components are expressed in  
582 a pan-neuronal fashion. Gal4-dependent expression of a presynaptically-tethered cognate ligand  
583 leads to activation of the receptor specifically in postsynaptic neurons downstream of the Gal4  
584 expressing population. Receptor activation then leads to proteolytic cleavage and release of the  
585 otherwise membrane-sequestered, orthogonal transcriptional activator QF. In this manner, the  
586 presynaptic neurons labeled by GFP under UAS control, can be visualized in conjunction with  
587 downstream targets, labeled by RFP under QUAS control. We applied *trans*-Tango to every R-  
588 neuron Gal4 driver to reveal, in principle, each output system in its entirety. However, in the  
589 absence of parallel methodology to demonstrate functional connectivity, we consider our findings  
590 to reveal “putative” targets, due to several potential caveats that merit consideration, some of which  
591 have been previously noted (Talay et al., 2017). In some cases, such as in R4d and R6, *trans*-Tango  
592 did not successfully yield RFP signal in the EB. This may be a consequence of insufficient  
593 expression levels of the synthetic ligand due to a weak Gal4 line, or a neural circuit that simply  
594 contains fewer synapses. Indeed, the Gal4 drivers that label R4d and R6 appear weaker, and are  
595 also some of the smallest populations in terms of cell number ( $8\pm 0$  and  $2\pm 0$  neurons PBH,  
596 respectively). However, a large or strongly Gal4-expressing GFP-positive population is not  
597 required to elicit a strong *trans*-Tango signal. We anecdotally observed strong RFP expression in  
598 other areas of the brain due to non-specific expression outside of the CX, even when the non-  
599 specific cells were sparse or weakly labeled. The strength of *trans*-Tango signal may also be  
600 determined by the neuron-specific expression level of the synthetic receptor, which cannot be  
601 assumed a priori to be uniformly expressed in every neuron throughout the brain, despite being  
602 under the control of a pan-neuronal promoter. This may result in sparse presynaptic labeling  
603 leading to strong postsynaptic labeling, or vice versa. This potential confound leads to the next  
604 consideration; a highly specific driver line is important to accurately interpret the postsynaptic  
605 signal. Particularly for the CX, where neurons between neuropil compartments are recurrently  
606 connected, any non-specific neuronal labeling in another CX neuropil outside of the EB may yield  
607 a false positive signal for a ring neuron driver *trans*-Tango experiment. In a hypothetical example,  
608 it would be difficult to disambiguate whether RFP-positive neurons that interconnect the PB and  
609 EB are downstream of the ring neuron class of interest, or a non-specific neuron in the PB.  
610 Considering this, we opted not to include *trans*-Tango results from R5 (58H05-Gal4); this driver  
611 line included several other neurons in other CX neuropils (data not shown). Finally, the potential  
612 for false-positive signal due to reporter sensitivity or mislocalization of the overexpressed ligand,  
613 must always be considered (Talay et al., 2017). Despite the requirement for further validation, the  
614 *trans*-Tango results herein reveal heretofore unknown wiring principles of the R-neuron network.  
615 The findings of these experiments are summarized in Fig.10.

616

### 617 **R1:**

618 Neurons trans-synaptically labeled when using the R1 driver 31A12-Gal4 included R-  
619 neurons of the R1 and R3p subclass, as well as columnar E-PG and, likely, PB<sub>G2-9</sub>.s-FBI2.b-  
620 NO<sub>3</sub>A.b (provisionally “P-F<sub>2</sub>N<sub>3</sub>”) neurons (Wolff et al., 2015). Thus, *trans*-Tango signal is  
621 detected in cell bodies of DALv2 neurons in the anterior cortex, as well as DM1-4 neurons in the

622 posterior cortex (Fig.8A1, 2, 3). Many of the labeled DALv2 neurons were also positive for GFP  
623 (Fig.8A3), indicating that R1 neurons form strong reciprocal connections among each other  
624 (homotypic interactions). In the EB neuropil, *trans*-Tango signal fills all compartments, but is  
625 enriched in EBip (Fig.8A4, A10), which is targeted by R3p neurons (heterotypic interactions).  
626 Accordingly, labeling is also detected in a subset of glomeruli of BU<sub>i</sub> (Fig.8A5), the dendritic  
627 compartment of R3p. *Trans*-Tango-positive projections of columnar neurons accounts for the  
628 labeling detected in the PB (Fig.8A8), outer EB domains (Fig.8A4, A10), and GA (Fig.8A11).  
629 Signal ventrally of the GA (Fig.8A11), filling the lateral surface of the LAL, is attributable to the  
630 reciprocally connected R1 neurons (Fig.8A5-A7, A11). In addition to E-PG neurons, the *trans*-  
631 Tango-positive columnar neurons also appeared to include P-F<sub>2</sub>N<sub>3</sub> neurons, based on signal  
632 detectable in the fan-shaped body and ventral noduli (Fig.8A9). The responsible connection  
633 between R1 and P-F<sub>2</sub>N<sub>3</sub> neurons to which this label could be attributable, could be a sparse,  
634 posteriorly projecting neurite of R1-neurons to the FB which was periodically observed (data not  
635 shown).

636  
637 **R2:**

638 Cells identifiable as targets of R2-neurons include other ring neurons of the R4d, R3d, and  
639 R2 subclasses, in addition to columnar E-PG neurons. In the anterior cortex, GFP and *trans*-Tango  
640 label overlaps weakly, and perhaps in only a small proportion of cell bodies (Fig.8B3), indicating  
641 that reciprocal connections among R2-neurons are present but not very pronounced. The EB  
642 neuropil is ubiquitously filled with *trans*-synaptic label, but shows enriched signal in EBic, which  
643 is targeted by R3d, and the outer rim of EBoc, innervated by R4d (Fig.8B4), suggesting prominent  
644 heterotypic interactions. In accordance with the notion that R3d and R4d are postsynaptic partners  
645 of R2, we find *trans*-Tango labeling in a posterior-lateral part of BUs (Fig.8B5), shown above to  
646 be dendritically innervated by R4d (see Fig.3A3-A4), and in the posterior region of the inferior  
647 bulb (pBU<sub>i</sub>), corresponding to R3d (Fig.8B5). Labeling of cell bodies in the posterior cortex,  
648 occupied by DM1-4 (Fig.8B2), and of neuropil including the PB (Fig.8B8), outer EB (Fig.8B10)  
649 and GA (Fig.8B11) is attributable to E-PG neurons targeted by R2. Sparse label in the FB  
650 corresponds to the through-going fibers of columnar E-PG neurons, in addition to other neuronal  
651 populations of unclear identity (Fig.8B9).

652  
653 **R3w:**

654 The R3w subclass could be viewed as an intermediary between outer and inner R-neurons  
655 in terms of the projection of proximal branches (ventral part of BUs) and distal branches (narrow  
656 EBic domain, reaching into EBoc). Correspondingly, R3w neurons, like outer subclasses R2 and  
657 R4m, target a good number of columnar E-PG neurons (Fig.8C2, C8, C11), in addition to a small  
658 number of R2 neurons (sparse RFP label in EBoc and BUs; Fig.8C4-C6). Strongest RFP signal is  
659 seen in the inner EB domains and BU<sub>i</sub>, indicating R3d, R3m, and particularly R3p, as major targets  
660 (Fig.8C4-C6, C10). It should be noted that the driver VT057232-Gal4, which is used here to label  
661 R3w, is also expressed in numerous additional neurons throughout the brain, which may account  
662 for some of the RFP signal (Fig.8C2). For example, staining of the ventral noduli (NO3; Fig.8C9,  
663 inset), presumably corresponding to one of the P-FN populations, is unlikely to be attributable to  
664 R3w R-neurons as presynaptic partners.

665



666 **R4m:**

667 R4m neurons innervate EBoc, similar to R2, but have their dendritic projection towards  
668 BUa. Using the R4m driver line 59B10-Gal4, we see trans-synaptic label of R-neuron subclasses  
669 R4m, R4d and R3d, as well as a large fraction of columnar E-PG neurons (Fig.8D). Signal is  
670 concentrated in EBic (R3d) and periphery of EBoc (R4d) (Fig.8D4, D10). In the BU, trans-  
671 synaptic label covers BUa, corroborating reciprocal interactions among R4m (Fig.8D7), in  
672 addition to the lateral part of BUs (R4d; Fig.8D5) and pBUi (R3d; Fig.8D5). There is a large  
673 number of RFP-positive DM1-4 columnar neurons in the posterior cortex (Fig.8D2), projecting  
674 dense arrays of fiber tracts that innervate the PB (Fig.8D8), through the FB (Fig.8D9), to the EB  
675 and GA (Fig.8D10-D11).

676

677 **R3d/4d:**

678 The driver line 80C07-Gal4 marks R3d neurons with axonal projections to EBic and  
679 dendritic innervation of pBUi. This pattern is confirmed when using the line in the context of trans-  
680 synaptic labeling (Fig.9A1, A5). However, likely as a consequence of enhancement of GFP signal  
681 with the use of anti-GFP antibody, we also saw GFP signal in the outer rim of EBoc and the lateral  
682 part of BUs, indicating that 80C07-Gal4 is also expressed in R4d neurons. It is therefore difficult  
683 to assign the observed trans-synaptic label induced by this line to either one of these populations.  
684 We observe trans-synaptic label in both R-neurons in the anterior cortex, and DM1-4 columnar  
685 neurons in the posterior cortex (Fig.9A1-A2). Approximately half of 80C07-expressing R-neurons  
686 are also labeled trans-synaptically, suggesting strong reciprocal connectivity among R3d and/or  
687 R4d (Fig.9A3). In the EB neuropil, *trans*-Tango signal is highly concentrated in EBic and EBip,  
688 and the outer rim of EBoc (Fig.9A4, A10). This pattern again argues for strong reciprocal  
689 interactions of R3d and R4d, as well as contacts between R3d and R3p. Trans-synaptic label in the  
690 BU also largely overlaps with GFP signal in pBUi and lateral part of BUs (Fig.9A5-A6), that are  
691 dendritically innervated by R3d and R4d neurons, respectively. Exclusive label of glomeruli in the  
692 dorsal part of BUi (Fig.9A5) corresponds to R3p which targets this region (see Fig.2F). Trans-  
693 synaptic labeling of columnar neurons is sparse, with only few cell bodies in the posterior cortex  
694 (Fig.9A2, A8), and faint/restricted labeling of the outer EB domains and the GA (Fig.9A10-A11).  
695 The identity of trans-synaptically labeled neurons spottily innervating the FB (Fig.9A9) is not  
696 clear.

697

698 **R3m:**

699 The pattern of trans-synaptically labeled neurons by the R3m driver 28E01-Gal4 largely  
700 resembles that described previously for R3d. R3m neurons have strong reciprocal interactions,  
701 with the majority of their cell bodies being positive for both GFP and RFP (Fig.9B1-B3). Based  
702 on the trans-synaptic labeling observed in EBic and EBip, as well as the periphery of EBoc  
703 (Fig.9B4), R3d, R3p and R4d neurons are also targeted by R3m. This is corroborated by labeling  
704 in the BU (Fig.9B5-B6), which includes pBUi (R3d), dorsal part of pBUi (R3p), and lateral part  
705 of BUs (R4d). Trans-synaptic labeling of E-PG neurons is sparse (Fig.9B8, B11).

706

707 **R3a:**

708 Whereas the inner R-neuron subclasses R3d, R3m and R3p preferentially form homotypic  
709 connections among each other, the R3a subclass targets EBic in a heterotypic manner. Thus, there  
710 is but little overlap of GFP and RFP in R-neuronal somata (Fig.9C1-C3). Strong target label is

711 seen in EBic and throughout BUi (Fig.9C5-C6), indicating inner R-neuron subclasses R3d and  
712 R3m as preferred targets of R3a. Sparse label in EBoc and BUs suggests that some R2 neurons are  
713 also among the R3a targets (Fig.9C4-C6, C10). Furthermore, a very small number of E-PG  
714 neurons, and a matching faint RFP signal in EBop and EBoc, as well as the GA, appear to be  
715 targeted by R3a (Fig.9C2, C4, C11).

### 716 **R3p:**

717 R3p resembles R3d and R3m in forming strong homotypic interactions, as seen from  
718 overlapping GFP and RFP signal in cell bodies (Fig.9D1, D3), EBip (Fig.9D1-D2, D4) and dorsal  
719 part of pBUi (Fig.9D5). In addition, based on extensive RFP signal throughout BUi (Fig.9D5-D6),  
720 R3p targets other subclasses of inner R-neurons, notably R3d and R3m. We observed only small  
721 numbers of RFP-positive E-PG neuronal cell bodies (Fig.9D2, D8), matching only faint label of  
722 PB, outer EB, and GA (Fig.9D4, D8, D10-D11).

723

### 724 **Discussion**

725 This work serves to build upon previous anatomical studies by further clarifying the  
726 neuronal architecture of the *Drosophila* ellipsoid body. Five definitive DN-cadherin domains  
727 constituting the EB neuropil provide fiducial landmarks with which neuron classes can be placed  
728 into spatial context. Based on this framework, we report several novel ring neuron subclasses and  
729 propose potential interactions between ring, columnar, and neuromodulatory neurons in the EB.  
730 Lastly, we experimentally mapped putative postsynaptic partners of R-neurons using *trans*-Tango,  
731 revealing insight into how information may be distributed throughout the EB and the rest of the  
732 CX. In addition to the neuroanatomical description of different populations, the identification of  
733 driver lines enables genetic access to label or manipulate these populations. This provides an entry  
734 point for future studies to probe the functional properties of each class and test the interactions  
735 proposed herein. In the following, we summarize the primary findings, speculate on the functional  
736 significance of CX wiring principles, and place our study into a developmental-neuroanatomical  
737 context with previous works in *Drosophila* and homologous structures in other insects.

### 738 **Information flow in the ellipsoid body network: input, recurrence, output, and** 739 **neuromodulation**

740 The CX is viewed as a critical hub for goal-directed navigational behavior in insects.  
741 Streams of sensory information from different modalities must converge onto this center of  
742 sensorimotor integration to guide navigational decisions based on current trajectory, learned  
743 information, and motivational state (Heinze, 2017). Central to this notion was the identification of  
744 a stable compass representation that tracks the flies heading in the E-PG neuron population. The  
745 robustness of this neural correlate of angular orientation, manifested as a single calcium activity  
746 “bump” that moves around the EB, depends on both visual and proprioceptive cues (Seelig and  
747 Jayaraman, 2015). Heavily relying upon studies in other insect species as a basis for comparison  
748 (Jundi et al., 2014), recent progress has been made towards identifying the neural pathways that  
749 transmit sensory information to the *Drosophila* CX, with visual input being the most well  
750 characterized. The fly CX receives visual information via the anterior visual pathway (AVP), a  
751 circuit defined by three successive layers. Information is transmitted from the optic lobe medulla  
752 to the anterior optic tubercle, from the tubercle to the bulb, and from there to the ellipsoid body,  
753 via medullo-tubercular (MeTu), tuberculo-bulbar (TuBu), and DALv2 ring neurons (R-neurons),  
754 respectively (Omoto et al., 2017). Parallel ensembles of TuBu neurons terminate in a

755 topographically-organized fashion onto the microglomerular dendrites of distinct R-neuron  
756 subclasses within the bulb (Omoto et al., 2017). Specific computations are implemented across  
757 successive layers in this pathway, such as the integration of recent visual history and self-motion,  
758 which may inform downstream behavior (Shiozaki and Kazama, 2017; Sun et al., 2017). Ring  
759 neurons transmit processed visual information concerning features and landmarks to the EB, likely  
760 as a stable allothetic reference to guide bump dynamics in E-PG neurons (proposed in Seelig and  
761 Jayaraman, 2015; Turner-Evans et al., 2017). Indeed, we provide evidence that R2 neurons, which  
762 are tuned to visual features (Seelig and Jayaraman, 2013), provides direct presynaptic input to E-  
763 PG neurons (Fig.8B; Fig.10). The calcium activity bump in E-PG neurons also shift in total  
764 darkness, demonstrating the existence of a proprioceptive input channel that can update the  
765 heading representation in the EB in the absence of visual input. We posit that transmission of  
766 idiothetic cues to the CX is mediated in part by R1 and/or ExR4 neurons, as their neurite  
767 distribution and polarity suggests feedback from the LAL, a proposed motor signaling center  
768 (Fig.2; Supp. Fig.2; Fig.6) (Namiki and Kanzaki, 2016).

769 Conceivably, the information received by different R-neuron subclasses is transmitted to  
770 their ring-shaped neurites, and is processed via connections within the same subclass (homotypic  
771 interactions) and/or between subclasses (heterotypic interactions), the extent of which depends on  
772 the R-neuron subclass in question (Fig.8; Fig.9; Fig.10). As such, the R-neuron system likely  
773 displays recurrent connectivity to enable persistent activity required for memory processes, as has  
774 been shown for mushroom body circuits that support courtship memory (Zhao et al., 2018). Indeed,  
775 R3d (or R3c\*) neurons, which comprise a critical nucleus of visual working memory (Neuser et  
776 al., 2008; Rieche et al., 2018), display prominent homotypic interactions (Fig.9A; Fig.10). Future  
777 work to define the mechanisms underlying intra-subclass interactions and experiments to perturb  
778 them, are required to assess the functional significance of these homotypic interactions.

779 R-neurons, particularly subclasses of which occupy peripheral EB domains, provide input  
780 to several different columnar neuron populations. To our knowledge, this study provides novel  
781 insight into the nature of subclass-specific, input-output communication between the ring and  
782 columnar networks. An important avenue of future work will be to elucidate the tuning properties  
783 of each R-neuron subclass and determine the contribution of each input to compass representation.  
784 Presumably, R-neuron subclasses that provide prominent, direct input to E-PG neurons, such as  
785 R2 or R4m (Fig.10), would exhibit the most influence over compass representation.

786 Circuit flexibility is likely facilitated by neuromodulatory input on a moment-by-moment  
787 basis, which may reconfigure information flow through the network and thus the output of the  
788 system. Neuromodulation would likely occur at multiple processing stages, as evidenced by the  
789 wide-spread neurites of dopaminergic neurons. For example, a single PPM3 neuron, innervates the  
790 GA/LAL, BU, and EBoc/op. We envisage that neurite-specific signaling and plasticity may  
791 regulate distinct processing nodes, akin to what has been demonstrated for dopaminergic neurons  
792 that encode protein hunger (Liu et al., 2017). Similarly, 5-HT may also influence R-neuron  
793 activity; projections from serotonergic neurons, likely from the posterior medial protocerebrum,  
794 dorsal cluster (PMPD; Pooryasin and Fiala, 2015), most prominently innervate EBic (Fig.5M).  
795 The effect of serotonin may be receptor and circuit specific; distinct 5-HT receptor isoforms are  
796 differentially expressed in specific R-neuron subclasses (Gnerer et al., 2015).

797

## 798 **Three-dimensional architecture of the ellipsoid body**

799 For clarity, the five EB domains defined by the global marker DN-cadherin should be  
800 reconciled with previously used anatomical terminology of the EB (Omoto et al., 2017; Fig.1).  
801 Frontal sections of the EB at different anteroposterior depths shows that DN-cadherin domains are  
802 distinct, annular entities. These domains correspond to “layers” in other insects, and have  
803 sometimes been also referred to as layers in *Drosophila* as well (Young and Armstrong, 2010b).  
804 Therefore, N-cadherin EB domains are synonymous with layers. Each domain is best represented  
805 using a “dorsal standard view”: a horizontal section through the EB containing a lengthwise  
806 perspective of the EB canal (Fig.1). From this standard view, the N-cadherin domains are also  
807 clearly organized along the anteroposterior axis. Three anteroposterior subdivisions of the EB have  
808 been referred to as “shells”, in line with terminology used for the FB (Wolff et al., 2015). We  
809 propose that the anterior most shell encapsulates the anterior domain of the EB (EB<sub>A</sub>), and  
810 therefore consists of only one layer. The intermediate shell (called medial shell in Wolff et al.,  
811 2015) encapsulates the inner central (EB<sub>ic</sub>) and outer central (EB<sub>oc</sub>) domains, and consists of two  
812 layers. Finally, the posterior shell encapsulates the inner posterior (EB<sub>ip</sub>) and outer posterior  
813 (EB<sub>op</sub>) domains, and consists of two layers. For example, P-EN neurons occupy the EB<sub>op</sub> domain,  
814 which resides in the posterior EB shell (Fig.7D-E).

815 Lin et al., (2013) defined four substructures denoted as “rings” [EB<sub>A</sub> (Anterior), EB<sub>O</sub>  
816 (Outer), EB<sub>C</sub> (Center), EB<sub>P</sub> (Posterior)], which were based on anti-discs large (DLG)  
817 immunostaining and roughly correspond to the DN-cadherin domains. Like the DN-cadherin  
818 domains, each “ring” was proposed to contain specific R-neuron subclasses. Based on the ring  
819 neuron subclasses proposed by Lin et al., (2013) to comprise each “ring” (see below), we infer that  
820 EB<sub>A</sub> from Lin et al. (2013) corresponds to EB<sub>A</sub> and EB<sub>ic</sub> in our classification system. Furthermore,  
821 EB<sub>O</sub> is EB<sub>oc</sub>, EB<sub>C</sub> is EB<sub>ip</sub>, and EB<sub>P</sub> is EB<sub>op</sub>.

822 How does the annular domain structure of the *Drosophila* ellipsoid body compare to the  
823 lower division of the central body (CBL) described for other insects? Similar to the EB, the CBL  
824 represents a multilayered neuropil compartment formed by the neurite contributions of tangential  
825 and columnar elements. In insects such as locust (*Schistocerca gregaria*), which will be used as  
826 the primary basis for comparison in the following, the kidney bean or sausage-shaped CBL  
827 corresponds to the torus-shaped ellipsoid body in *Drosophila* (Ito et al., 2014; Pfeiffer and  
828 Homberg, 2014). In locusts, the CBL is effectively located ventrally of the upper division of the  
829 central body (CBU), whereas the homologous structures in *Drosophila* (ellipsoid body and fan-  
830 shaped body, respectively) are arranged in an antero-posterior fashion. This difference is reflective  
831 of a 60° anterior tilt of the locust neuraxis, as evidenced by the peduncle, which extends  
832 horizontally in flies but is oriented almost vertically in the locust (Hadeln et al., 2018). In the dung  
833 beetle (*Scarabaeus lamarcki*) and monarch butterfly (*Danaus plexippus*), the CBL are also  
834 sausage-shaped, but the neuraxis orientation is like that of *Drosophila* (Heinze and Reppert, 2012;  
835 Immonen et al., 2017). Differences in neuraxis orientation influence the comparison between the  
836 internal architecture of the locust CBL and fly EB. The locust CBL is subdivided along the dorso-  
837 ventral axis into 6 horizontal layers (although not stacked seamlessly on top of one another). Based  
838 on the expression of global markers, the *Drosophila* ellipsoid body is divided into toroidal domains  
839 (EB<sub>A/ic/oc/ip/op</sub>; Fig.1). Considering the tilt in neuraxis, we posit that dorsal strata (layers 1-2) of  
840 the locust CBL roughly correspond to more posterior domains (EB<sub>ip/op</sub>) of the fly EB, whereas  
841 ventral strata (layers 3-6) correspond to more anterior EB domains (EB<sub>A/ic/oc</sub>). Corroborating this

842 notion is the fact that fly P-EN neurons innervate EBop, and the locust homologues (called CL2  
843 neurons) innervate dorsal layers of the CBL (Müller et al., 1997).

#### 844 **Lineage-based architecture of the ellipsoid body**

845 The EB and its domains, as well as other structures of the CX, are established by the neurite  
846 contributions of distinct neuronal populations. How is the neuronal diversity and connectivity of  
847 the CX developmentally established? The CX, and brain in general, is organized into structural-  
848 genetic modules called lineages; a lineage comprises the set of sibling neurons derived from an  
849 individual neural progenitor (neuroblasts). Each neuroblast forms a spatially discrete cluster of  
850 neurons with shared wiring properties; sibling neurons extend a limited number of fasciculated  
851 axon tract(s) and innervate specific brain compartments. Most brain lineages are “type I”  
852 neuroblast lineages, whose neuroblasts undergo a series of asymmetric divisions each of which  
853 renews the neuroblast and produces a ganglion mother cell. Columnar neurons of the CX are  
854 generated from four type II lineages which are larger and more complex than type I, with  
855 neuroblasts first producing a set of intermediate progenitors which in turn, give rise to ganglion  
856 mother cells (Bello et al., 2008; Boone and Doe, 2008; Bowman et al., 2008; Doe, 2017; Wang et  
857 al., 2014).

858 While the columnar neurons contributing to the EB are derived from type II lineages, the  
859 tangential elements (R-neurons) are largely derived from a single paired type I neuroblast, forming  
860 the lineage DALv2 (also called EBa1) (Ito et al., 2013; Omoto et al., 2017; Wong et al., 2013; Yu  
861 et al., 2013). Neurons of the DALv2 lineage have been studied in developmental contexts in a  
862 number of previous works (Kumar et al., 2009; Larsen et al., 2009; Lovick et al., 2017; Minocha  
863 et al., 2017; Spindler and Hartenstein, 2011; Xie et al., 2017). Production of secondary neurons by  
864 DALv2 begin around 24h after hatching (Lovick and Hartenstein, 2015). According to Kumar et  
865 al. (2009), one of the DALv2 hemilineages undergoes apoptotic cell death, implying that the  
866 DALv2 R-neurons forming the adult ellipsoid body represent a single hemilineage. cursory heat-  
867 shock inducible single-cell clonal analysis carried out in the present study suggests that distinct R-  
868 neuron subclasses are born during specific time windows and therefore represent sublineages of  
869 DALv2 (Fig.4). Thus, clonal induction shortly after the onset of secondary neuroblast proliferation  
870 (20-48h after hatching) yielded exclusively outer R-neurons of the R4m subclass. At increasingly  
871 later time points, these types of clones become rare, and disappeared entirely at induction times  
872 after 96h. The converse is the case for inner ring neurons (R3d/m), which could be induced in  
873 increasing numbers with later time points of induction. Given that only a fraction of the overall  
874 number of R-neuron subclasses was represented among our clones, additional studies are required  
875 to settle the exact birth order of different R-neuron subclasses.

#### 876 **Ontology of the ring neuron classification system**

877 In the following, we provide a brief historical account of ring neuron definitions, attempt  
878 to resolve discrepancies in the literature when possible, and provide rationale for naming  
879 conventions used in this work.

880 Based on the description by Hanesch et al., (1989), the R-neuron type corresponds to ring  
881 neurons of the DALv2 lineage, with four R-neuron subclasses described in this initial study (R1-  
882 4). Two other ring neuron types were designated as “extrinsic ring neurons” (ExR-neurons), based  
883 on large projections outside of the EB; in this study, we pool neurons with this feature into a single

884 type, the ExR-neurons. The first type of extrinsic R-neuron (the ExR1 subclass) described in  
885 Hanesch et al., (1989) likely corresponds to helicon cells. The second type (the ExR2 subclass)  
886 was not fully reconstructed by Hanesch et al., (1989), but due to its innervation of the caudal EB,  
887 ExR2 may correspond to the EBop-innervating PPM3 dopaminergic neuron (Fig.5N-Q), and thus  
888 our rationale for this designation. The serotonergic neurons that innervate the EB, likely the PMPD  
889 neurons, we designate as ExR3. Therefore, ExR1-3 are posteriorly localized ExR-neurons, likely  
890 deriving from the DM4-6 lineages. Due to its wide arborization and non-DALv2 based origin, we  
891 designate ring neurons of lineage BAMv1, with perikarya in the anterior cortex, as a fourth type of  
892 ExR-neuron (ExR4); we cannot exclude the possibility that ExR2 from Hanesch et al., (1989) may  
893 correspond to ExR4-neurons, as they too innervate the caudal EB. Furthermore, the “P”-neurons,  
894 described in Lin et al. (2013) as having ventrally localized cell bodies and also innervate the caudal  
895 EB, likely correspond to what we designate as ExR4-neurons.

896 Renn et al., (1999) was the first to conduct a genetic analysis of the EB neuropil, using  
897 enhancer-trap technology. Renn et al. (1999) described Line c105 to label R1 neurons (Supp.  
898 Fig.1A), due to their “inside-out” arborization pattern, inner ring localization, and extension into  
899 the posterior layers of the EB, a similar description to that of Hanesch et al. (1989). However,  
900 c105-positive R1 neurons exhibit ventrally projecting neurites into the LAL and lack bulb  
901 microglomeruli (Renn et al., 1999; Supp. Fig.1A3-5), in contrast to what was defined as R1 in  
902 Hanesch et al., (1989). Therefore, we speculate that Renn et al., (1999) identified a novel R-neuron  
903 class, distinct from R1 as described by Hanesch et al., (1989). However, due to R1 being the  
904 predominant designation this R-neuron subclass thereafter (Lin et al., 2013; Renn et al., 1999;  
905 Young and Armstrong, 2010b), we retain this classification in our study.

906 If R1 from Renn et al., (1999) was a previously undescribed class, what was R1 from  
907 Hanesch et al., (1989)? Based on the camera lucida drawn Golgi stained preparations and the  
908 description of R1 being “restricted to the inner zone lining the EB canal”, we propose that R1 from  
909 Hanesch et al., (1989) was interpreted by Renn et al., (1999) as R3. Henceforth, the predominant  
910 description of R3, which has been heavily investigated for their role in visual working memory, is  
911 that of “inner ring” R-neurons, a convention we also therefore retain (Kuntz et al., 2012; Lin et al.,  
912 2013; Neuser et al., 2008; Omoto et al., 2017; Young and Armstrong, 2010b). However, it is  
913 unclear which of the several R3-neuron subclasses with bulb microglomeruli identified in this  
914 study (R3m, R3d, R3p, or R3c\*), correspond to R1 described in Hanesch et al. (1989).

915 Presuming R1 being renamed R3 by later authors, which R-neuron subclass corresponds  
916 to R3 in Hanesch et al., (1989)? R3 was shown to have an inside-out innervation pattern, restricted  
917 to the rostral half of the EB, and importantly, exhibited branches with terminals in the inner and  
918 outer ring (Hanesch et al., 1989). To our knowledge, this R-neuron subclass has not been described  
919 in any study thereafter, and likely corresponds to R3w of the present study (Fig.2G).

920 R4 was described by Hanesch et al., (1989) to project in an “outside-in” fashion and extend  
921 terminals into the outermost zone. Renn et al. (1999), noted two neuron subclasses that exhibit  
922 these features, and referred to these “R4-type” neurons as R4m and R4d. The camera lucida  
923 drawing of R4 in Hanesch et al., (1989) displays a ventrally localized microglomerulus (likely  
924 corresponding to BUa), a description that matches that of R4m in subsequent studies (Renn et al.,

925 1999); we postulate that R4d was a class that exhibited R4-like wiring properties, newly identified  
926 by Renn et al., (1999) altogether.

927 R2 in former studies [Hanesch et al., 1989; labeled by c42 (Supp. Fig.1B; Renn et al., 1999)  
928 and EB1-Gal4 (Supp. Fig.1C; Young and Armstrong, 2010b) has axons within the EBoc domain,  
929 along with R4m (Fig.3B5-B6). In a more recent paper (Lin et al., 2013), the designation “R2”  
930 became associated with neurons projecting to the “anterior ring” (synonymous with EBa from this  
931 study). The designation of these anterior EB R-neurons as “R2” has carried forward to other  
932 studies, when their critical role in the regulation of sleep homeostasis was identified (Donlea et al.,  
933 2018; Liu et al., 2016). It should be noted that Liu et al., (2016) documented the distinction between  
934 what had historically been referred to as R2, and what had been referred as “R2” in Lin et al.,  
935 (2013). “R2” in Lin et al. (2013) appears morphologically similar to a subclass revealed by the 52y  
936 driver in Young and Armstrong (2010), which were not given a specific name. We used the name  
937 R5 for these anterior R-neurons (Omoto et al., 2017) and propose to retain this designation to  
938 prevent future studies from equating them with what has been historically referred to as R2.

939 In more recent studies, the driver 38H02-Gal4 has been described as labeling R4 (or an R4-  
940 subset), in several studies (Dus et al., 2013; Ofstad et al., 2011; Park et al., 2016). 38H02-Gal4  
941 does in fact label R4m (based on BUa microglomeruli and “outside-in” EBoc innervation pattern),  
942 but also strongly labels R5 (Supp. Fig.1J). Two other drivers, 15B07-Gal4 and 28D01-Gal4, were  
943 used to target EB neurons required for visual-thermal associations in place learning (Ofstad et al.,  
944 2011), and were described as labeling “R1 and R4”, or “R1 alone”, respectively. Anatomical re-  
945 assessment of these drivers reveals that 15B07-Gal4 labels R3d and R3p (or R3c\*) and R4d (Supp.  
946 Fig.1I), whereas 28D01-Gal4 labels a neuron subclass indicative of R3m (Supp. Fig.1D).

947 In summary, the dorsal view of the EB in conjunction with DN-cadherin immunostaining  
948 provide criteria to more definitively identify ring neuron subclasses for future studies. The model  
949 organism *Drosophila* offers unique advantages to examine the circuit motifs that support the  
950 broadly relevant computations underlying the processes attributed to the CX; 1) the neurons  
951 comprising the CX are spatially and numerically confined, 2) genetic access to label, assess  
952 connectivity between, or functionally manipulate, specific neuron types within it, and 3)  
953 amenability to electro- or optophysiological recordings, oftentimes in the behaving animal. To  
954 fully leverage these advantages, we provide a systematic description of the ring neuron subclasses  
955 comprising the EB, genetic tools to access them, and provide insight into their interactions with  
956 other neurons of the CX.

957

958

959

960

961

**Figure 1**

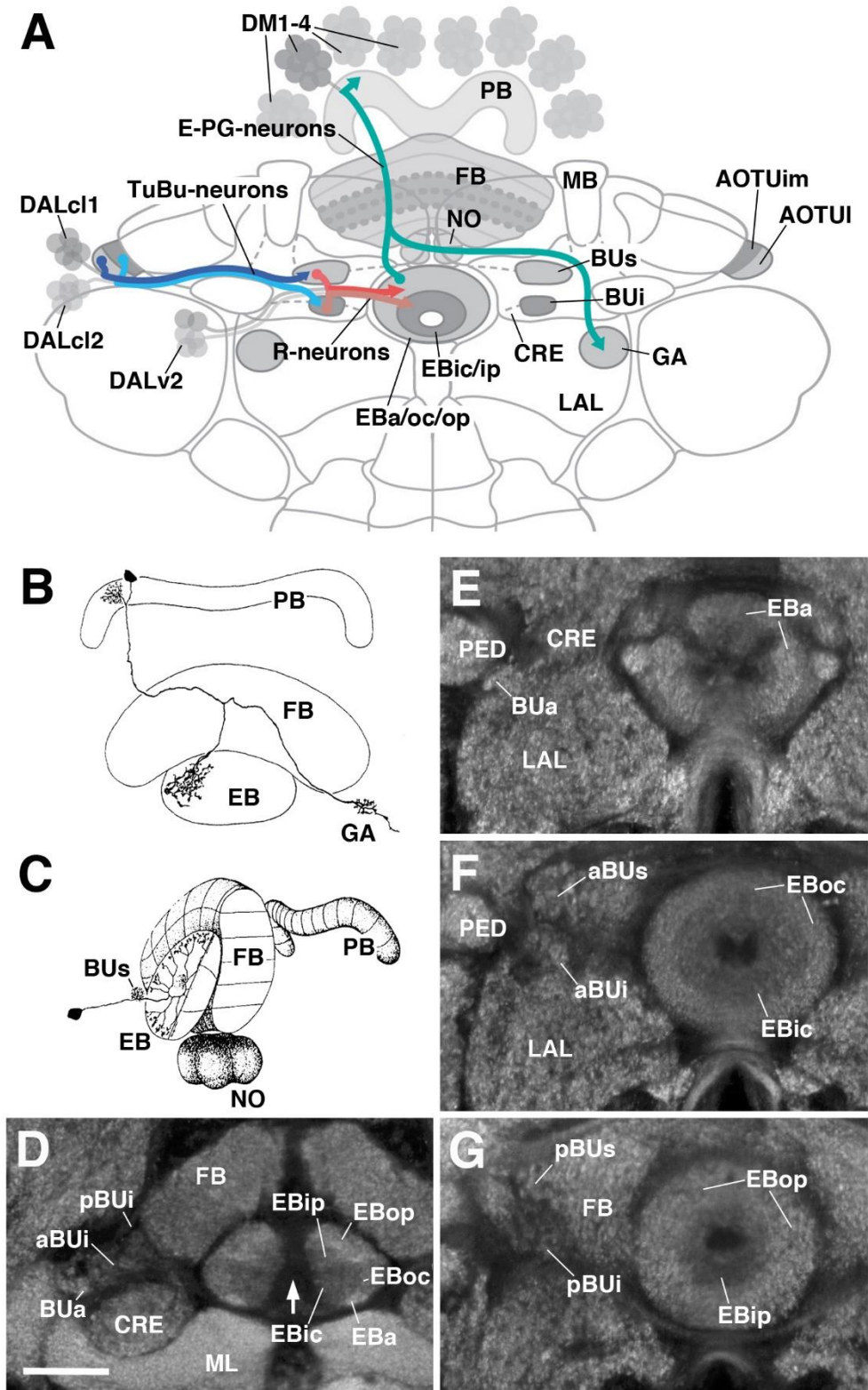



963 **Figure 1**

964 General overview of the ellipsoid body: neuronal interactions and compartmentalization

965 (A) Schematized overview of interacting neuronal populations of the ellipsoid body. Gray  
966 indicates relevant lineages, neuron types, and neuropil compartments. The anterior visual pathway,  
967 divided into the superior and inferior bulb pathways, provides input to R-neurons. Superior bulb  
968 pathway: Tuberculo-bulbar (TuBu) neurons of lineage DALcl1 (dark blue) project from the lateral  
969 domain of the anterior optic tubercle (AOTU1) to the superior bulb (BUs), which then innervate  
970 R-neurons (dark red) that project to the anterior and outer central domains of the ellipsoid body  
971 (EBa/oc). Inferior bulb pathway: TuBu neurons of lineage DALcl2 (light blue) project from the  
972 intermediate medial domain of the anterior optic tubercle (AOTUim) to the inferior bulb (BUi),  
973 which then innervate R-neurons (light red) that project to the inner central and inner posterior  
974 domains of the ellipsoid body (EBic/ip). Columnar elements of the DM lineages (turquoise), such  
975 as E-PG neurons, form recurrent circuitry interconnecting the protocerebral bridge (PB), EB, and  
976 gall (GA) of the lateral accessory lobe (LAL). Many other neuron types not shown interconnect  
977 the fan-shaped body (FB) and noduli (NO) as well.

978 (B and C) Representative examples of columnar and tangential elements of the ellipsoid body. (B)  
979 E-PG neuron and (C) R2-neuron. Images adapted from Hanesch et al., 1989.

980 (D-G) Confocal z-projections illustrating domains of the bulb and ellipsoid body, visible with DN-  
981 cadherin (DNCad) immunostaining (gray). (D) horizontal section; (E-G) frontal sections at three  
982 different antero-posterior depths.

983 (D) Horizontal section (anterior pointing downward) depicting the length of the ellipsoid body  
984 canal (arrow). The EB is situated within an indentation of the FB, located posteriorly. All five EB  
985 domains, distinguishable based on DNCad expression levels, are visible: High intensity staining in  
986 the anterior-most part of the EB defines the anterior domain (EBa). Posterior to EBa is the inner  
987 central domain (EBic) with lower DNCad signal, located medially adjacent to the outer central  
988 domain (EBoc) with moderate DNCad signal. Furthest posterior are the inner posterior (EBip) and  
989 outer posterior (EBop) domains with low and high intensity DNCad signal, respectively. In this  
990 horizontal section, the anterior bulb (BUa) as well as the anterior and posterior regions of the  
991 inferior bulb (a/pBUi) are visible, but the superior bulb, located more dorsally, is not.

992 (E) Anterior section: the anterior bulb (BUa) and anterior domain of the EB (EBa) are visible. In  
993 addition, the anterior-most part of inner central domain (EBic) is also visible (low intensity region  
994 proximal to the EB canal).

995 (F) Intermediate section: the anterior regions of the superior bulb (aBUs) and inferior bulb (aBUi),  
996 as well as the inner central (EBic) and outer central (EBoc) domains of the ellipsoid body are  
997 visible.

998 (G) Posterior section: the posterior regions of the superior bulb (pBUs) and inferior bulb (pBUi),  
999 as well as the inner posterior (EBip) and outer posterior (EBop) domains of the ellipsoid body are  
1000 visible.

1001 Other abbreviations: CRE, crepine; MB, mushroom body; ML and PED, medial lobe and peduncle  
1002 of the mushroom body, respectively.

**Figure 2**

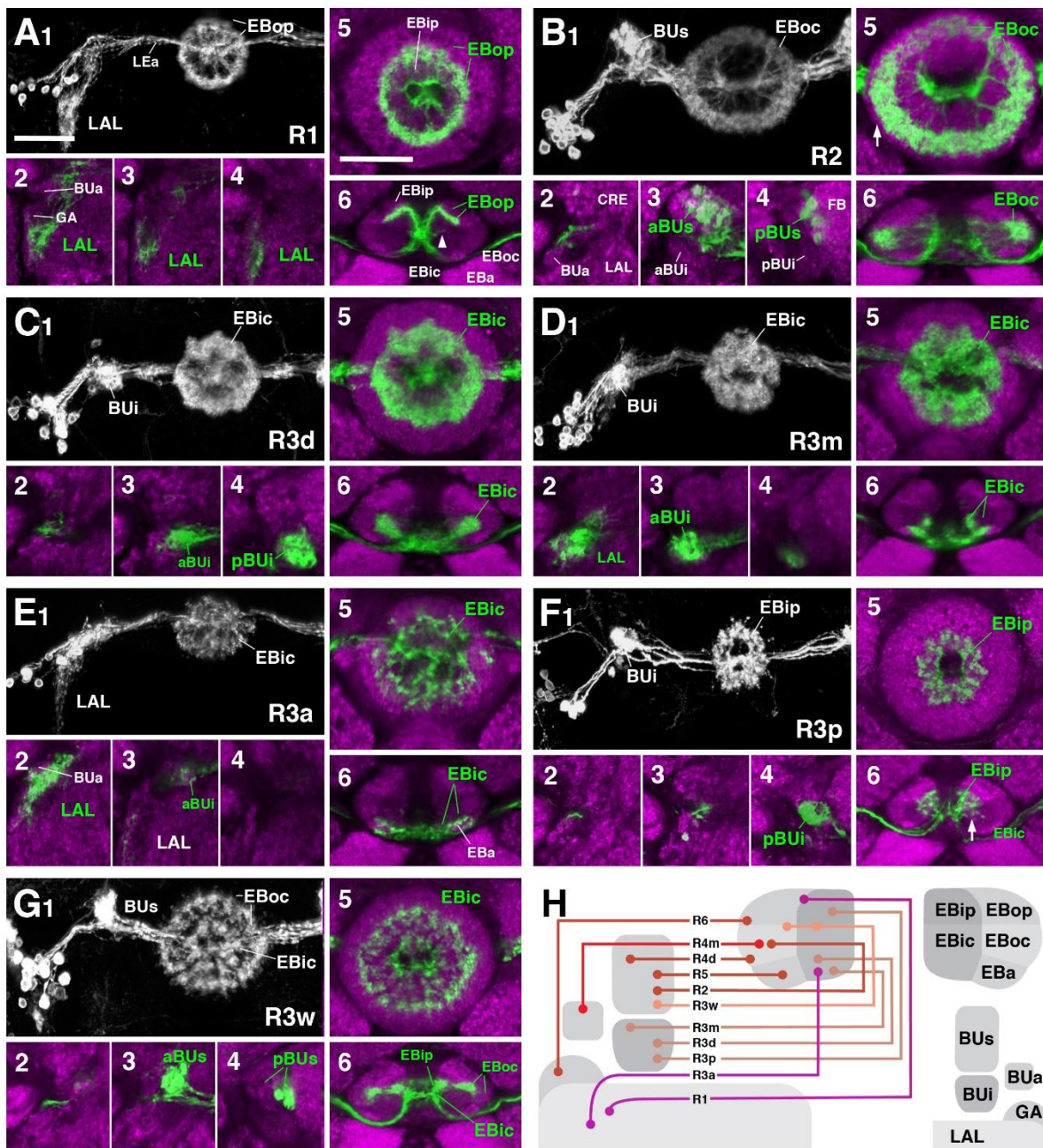

1003

1004 **Figure 2**

1005 R-neuron subclasses of lineage DALv2/EBa1 with centrifugal arborizations

1006 (A-G) Confocal z-projections of Gal4 drivers that label distinct R-neuron subclasses. Each lettered,  
 1007 six-paneled module corresponds to an individual driver labeled with 10xUAS-mCD8::GFP.  
 1008 Within each module, top left (1) is a grayscale z-projection of the specific subclass (cell bodies on  
 1009 left), and its corresponding name in the bottom right corner. Large white annotations designate the  
 1010 primary domains of innervation by the subclass. In remaining module panels, the GFP-labeled

1011 neurons are shown in green; neuropil is labeled with anti-DN-cadherin (magenta). Bottom left  
1012 panels (2-4) are three frontal sections of the bulb at different antero-posterior depths (as described  
1013 in Fig.1); from left to right: anterior section containing BUa, intermediate section containing aBUs  
1014 and aBUi, posterior section containing pBUs and pBUi. Some subclasses (R1 and R3a) innervate  
1015 the lateral accessory lobe (LAL) rather than the bulb, in which case the same sections are shown  
1016 at a more ventral position. Top right (5) is a higher magnification, frontal view of the ellipsoid  
1017 body at an antero-posterior level (anterior, intermediate, or posterior) that highlights the circular  
1018 arbor of a given driver most clearly. Bottom right (6) is a horizontal section visualizing all five  
1019 DN-cadherin positive domains. Highlighted in large green text is the domain predominantly  
1020 innervated by the R-neuron subclass; smaller green text signifies additional regions of innervation.  
1021 Small white text in all panels denotes relevant spatial landmarks.

1022 (A1-6) R31A12-Gal4 (R1). (A1-5) Refer to Supp. Movie 1. (A1) R1 projects from the LAL to  
1023 EBop. For all DALv2 R-neurons, the anterior component of the lateral ellipsoid fascicle (LEa)  
1024 comprises the bridge between proximal and distal, annular neurites. (A2-4) Ventral neurites of R1  
1025 extend in the lateral LAL, medially adjacent of the gall (GA). (A5) Posterior EB section. (A6;  
1026 Refer to Supp. Movie 2) R1 neurites in the EB line the anterior-most border of EBop, along the  
1027 EBip-EBop interface. Additional, very small projections emanate from canal projections, along  
1028 the EBip-EBic interface (arrowhead; A6).

1029 (B1-6) R78B06-Gal4 (R2). (B1-5) Refer to Supp. Movie 3. (B1) R2 projects from BUs to EBoc.  
1030 (B2) No significant innervation in BUa; GFP signal corresponds to bypassing neurites. (B3) R2  
1031 neurons exhibit most of their microglomeruli in aBUs, but (B4) also some in pBUs. (B5)  
1032 Intermediate EB section; arrow indicates peripheral fringe of EBoc which is not innervated. (B6;  
1033 Refer to Supp. Movie 4) R2 exhibits restricted innervation of EBoc; GFP signal in EBic is passing  
1034 neurites.

1035 (C1-6) R80C07-Gal4 (R3d - *distal*). (C1-5) Refer to Supp. Movie 5. (C1) R3d projects from BUi  
1036 to EBic. (C2) No significant innervation in BUa; GFP signal corresponds to bypassing neurites.  
1037 (C4) R3d neurons exhibit most of their microglomeruli in pBUi, but (C3) also some in aBUi. (C5)  
1038 Intermediate EB section. (C6; Refer to Supp. Movie 6) R3d fills most of EBic.

1039 (D1-6) R28E01-Gal4 (R3m - *medial*). (D1-5) Refer to Supp. Movie 7. (D1) R3m projects from  
1040 BUi to EBic. (D3) R3m neurons exhibit most of their microglomeruli in aBUi, but (D2) possibly  
1041 also extend fibrous projections in the LAL, adjacent to BUa. (D4) No significant innervation in  
1042 pBU. (D5) Anterior EB section. (D6; Refer to Supp. Movie 8) R3m fills complementary region of  
1043 EBic relative to R3d.

1044 (E1-6) R12G08-Gal4 (R3a - *anterior*). (E1-5) Refer to Supp. Movie 9. (E1) R3a projects from the  
1045 LAL to EBic. (E2) The LAL projections of R3a neurons are more closely related to BUa, than that  
1046 of R1 neurons (A2), and (E3) may also exhibit very sparse projections in aBUi. (E4) No significant  
1047 innervation in pBU. (E5) Anterior EB section. (E6; Refer to Supp. Movie 10) The EB neurites of  
1048 R3a surround EBa.

1049 (F1-6) VT063949-Gal4 (R3p - *posterior*). (F1-5) Refer to Supp. Movie 11. (F1) R3p projects from  
1050 BUi to EBip. (F2-3) No significant innervation in BUa and aBU; GFP signal corresponds to  
1051 bypassing neurites. (F4) R3p neurons exhibit their microglomeruli in pBUi. (F5) Posterior EB

1052 section. R3p neurites in the EB densely fill EBip, but (F6; Refer to Supp. Movie 12) also appear  
1053 to project anteriorly, encroaching on EBic.

1054 (G1-6) VT057232-Gal4 (R3w - *wide*). (G1-5) Refer to Supp. Movie 13. (G1) R3w projects from  
1055 BUs to EBic. (G2) No significant innervation in BUa; GFP signal corresponds to bypassing  
1056 neurites. (G3-4) R3w neurons exhibit their microglomeruli in aBUs and pBUs. (G5) Posterior EB  
1057 section. (G6; Refer to Supp. Movie 14) R3w neurites line the posterior border of EBic, and extend  
1058 into EBip. Neurites also extend distally towards EBoc, and may encroach on it.

1059 (H) Schematized overview of R-neuron domain innervation patterns (Fig.2/3 included).

1060 Other abbreviations: CRE, crepine.

1061

1062

1063

1064

1065

1066

1067

1068

1069

1070

1071

1072

1073

1074

1075

1076

1077

1078

1079

1080

### Figure 3

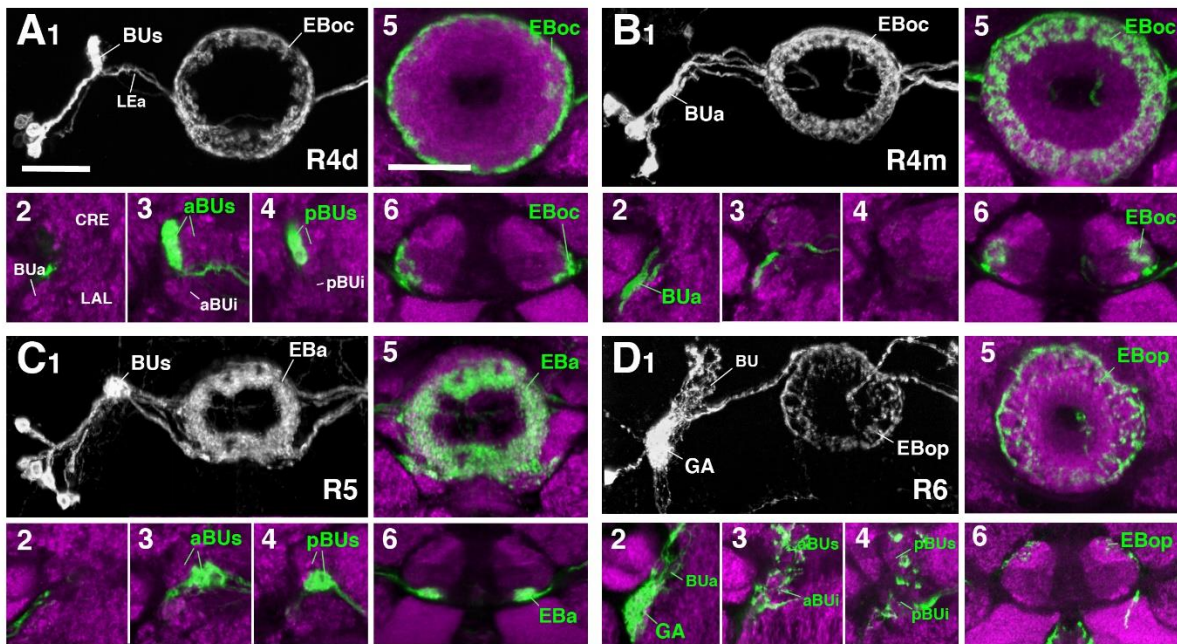

1081

### 1082 **Figure 3**

1083 R-neuron subclasses of lineage DALv2/EBa1 with centripetal arborizations

1084 (A-D) Similar modular format of panels as described in legend for Fig. 2.

1085 (A1-6) R12B01-Gal4 (R4d - *distal*). (A1-5) Refer to Supp. Movie 15. (A1) R4d projects from BUUs  
 1086 to EBoc. (A2) No significant innervation in BUa; GFP signal corresponds to bypassing neurites.  
 1087 (A3-4) R4d neurons exhibit their microglomeruli in aBUs and pBUs. (A5) Intermediate EB  
 1088 section. (A6; Refer to Supp. Movie 16) R4d neurites line the distal-most border of EBoc, and  
 1089 typically extend from posterior edge of EBa to the anterior edge of EBop.

1090 (B1-6) R59B10-Gal4 (R4m - *medial*). (B1-5) Refer to Supp. Movie 17. (B1) R4m projects from  
 1091 BUa to EBoc. (B2-4) Innervation only in BUa. GFP signal in aBU corresponds to bypassing  
 1092 neurites. (B5) Intermediate EB section. (B6; Refer to Supp. Movie 18) R4m neurites innervate  
 1093 EBoc.

1094 (C1-6) R58H05-Gal4 (R5). (C1-5) Refer to Supp. Movie 19. (C1) R5 projects from BUUs to EBa.  
 1095 (C2) No significant innervation in BUa; GFP signal corresponds to bypassing neurites. (C3-4) R5  
 1096 neurons exhibit their microglomeruli in aBUs and pBUs. (C5) Anterior EB section. (C6; Refer to  
 1097 Supp. Movie 20) R5 neurites innervate EBa.

1098 (D1-6) VT011965-Gal4 (R6). (D1-5) Refer to Supp. Movie 21. (D1) R6 projects from the Gall to  
 1099 EBop. (D2-4) R6 neurites are highly dense in the gall (GA), but also diffusely innervates all  
 1100 domains of BU. (D5) Anterior EB section. (D6; Refer to Supp. Movie 22) R6 form sparse  
 1101 projections in the posterior boundary of EBop and extend fine processes anteriorly into EBop.

1102 Other abbreviations: CRE, crepine; LAL, lateral accessory lobe; LEa, anterior component of the  
 1103 lateral ellipsoid fascicle.

## Figure 4

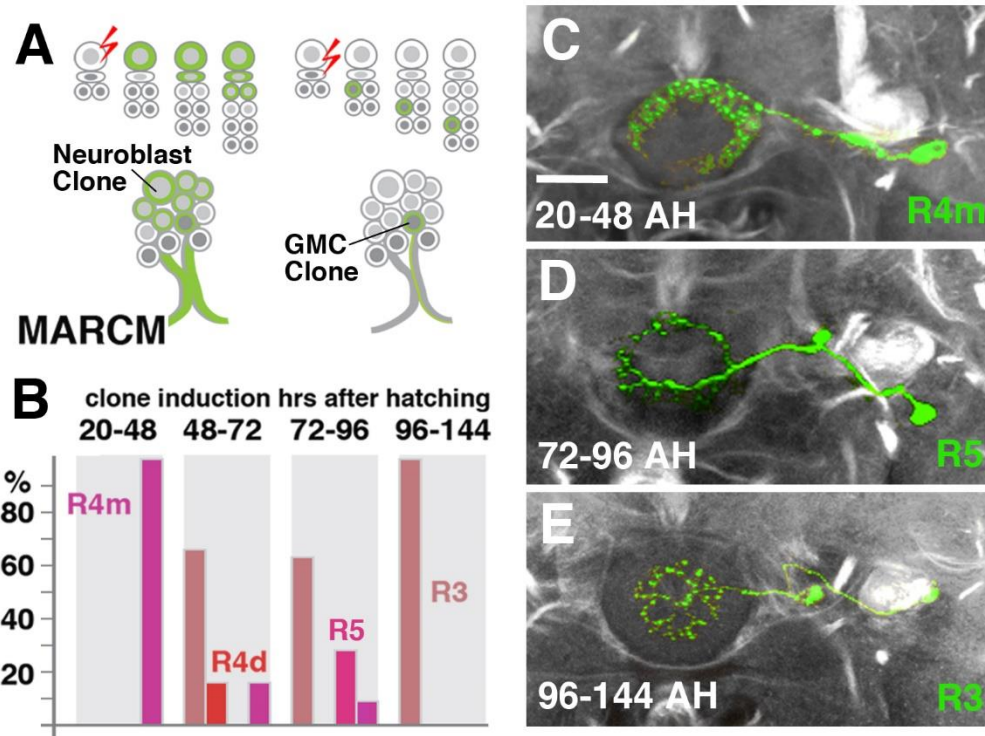

1104

### 1105 **Figure 4**

1106 R-neuron subclasses represent sublineages of DALv2

1107 (A) Schematized overview of MARCM clone induction and resultant clone categories. Neuroblast  
1108 clones result in labeling of the entire lineage from induction onwards; ganglion mother cell (GMC)  
1109 clones result in singly-labeled neurons.

1110 (B) Histogram of single cell clone R-neuron subclasses generated by temperature shifts during  
1111 distinct time windows throughout larval development. A total of 33 single cell clones were  
1112 generated, % reflect the proportion of clones of a given subclass generated during a given time  
1113 window.

1114 (C-E) Representative clones (green) from three-time windows after hatching (AH). Axon tracts  
1115 labeled by anti-Neuroglian (gray).

1116 (C) R4m

1117 (D) R5

1118 (E) R3

1119

1120

1121

Figure 5

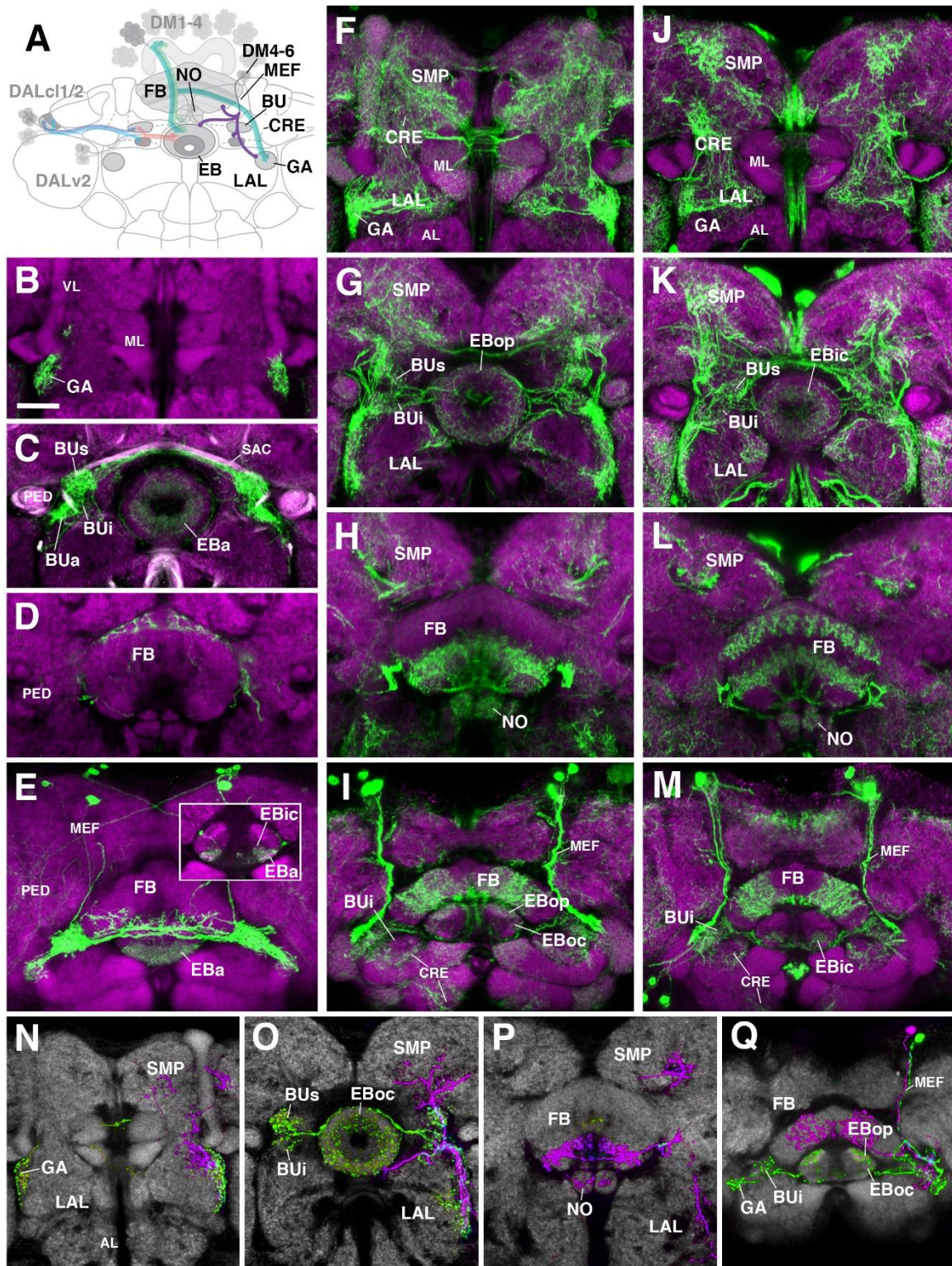

1122

1123

1124 **Figure 5**

1125 Posterior ExR-neuron subclasses of lineage CM4, CM3, CM1/DM4-6

1126 (A) Schematized overview of interacting neuronal populations of the ellipsoid body from Fig.1,  
1127 now including posterior ExR-neurons of lineages DM4-DM6 (purple).

1128 (B-M) Confocal z-projections of Gal4 drivers that label distinct ExR-neuron subclasses with  
1129 posteriorly localized cell bodies. Each column corresponds to a single driver (green) labeled with  
1130 10xUAS-mCD8::GFP. Neuropil labeled by anti-DN-cadherin (magenta). Top three rows of each  
1131 column correspond to frontal sections at three different antero-posterior depths; from top to  
1132 bottom: anterior section containing the Gall (GA)/lateral accessory lobe (LAL), intermediate  
1133 section containing the ellipsoid body (EB) and bulbs (BU), posterior section containing the fan-  
1134 shaped body (FB) and noduli (NO). Bottom (fourth) row is a horizontal section visualizing the  
1135 length of the EB canal. Larger white annotations denote arborization-containing domains of  
1136 interest; smaller white annotations represent spatial landmarks.

1137 (B-E) R78A01-Gal4 (ExR1; “helicon cells”). Inset in (E) depicts dorsal view of the EB; ExR1  
1138 innervates EBa and the anterior part of EBic.

1139 (F-I) TH-Gal4 (ExR2 and other TH-positive neurons). (I) Dorsal view of the EB shows innervation  
1140 in EBop; sparse innervation in EBoc also detected.

1141 (J-M) TPH-Gal4 (ExR3 and other TPH-positive neurons). (M) Dorsal view of the EB shows  
1142 innervation in anterior part of EBic.

1143 (N-Q) Confocal z-projections of individually-labeled cells generated by MCFO using TH-Gal4.  
1144 Four panels depict the same sections and are organized in the same fashion as in B-M, but arranged  
1145 from left to right rather than top to bottom. Neuropil labeled by anti-DN-cadherin (gray). (N-O)  
1146 Green cell is ExR2 (PPM3-EB dopaminergic neuron); a single PPM3-EB innervates the Gall (GA)  
1147 of the lateral accessory lobe (LAL), lateral region of the LAL, and all BU domains on both sides.  
1148 (Q) Additional innervation includes prominent infiltration into EBop, and sparser innervation of  
1149 EBoc. Magenta cell is not an ExR-neuron (PPM3-FB dopaminergic neuron). Annotation format is  
1150 identical to that of B-M.

1151 Other abbreviations: AL, antennal lobe; CRE, crepine; MEF, medial equatorial fascicle; ML, VL,  
1152 and PED, medial lobe, vertical lobe, and peduncle of the mushroom body, respectively; SMP,  
1153 superior medial protocerebrum; BUs and BU<sub>i</sub>, superior and inferior domains of the bulb; anterior  
1154 (EB<sub>a</sub>), inner central (EB<sub>ic</sub>), outer central (EB<sub>oc</sub>), and outer posterior (EB<sub>op</sub>) domains of the  
1155 ellipsoid body.

1156

1157

1158

1159

1160



## Figure 6

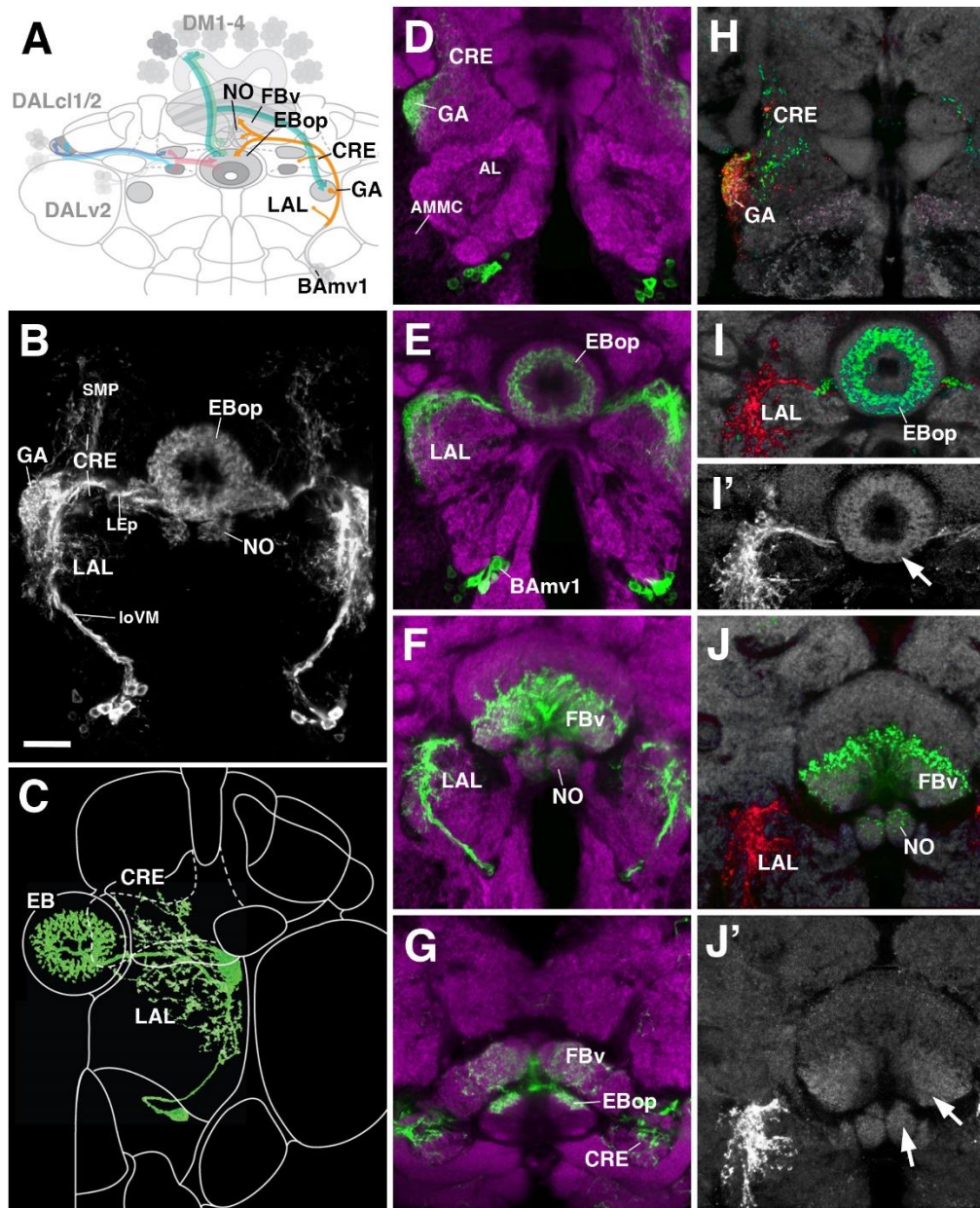

1161

### 1162 **Figure 6**

1163 Anterior ExR-neuron subclass of lineage BAMv1/LALv1

1164 (A) Schematized overview of interacting neuronal populations of the ellipsoid body from Fig.1,  
1165 now including anterior ExR-neurons of lineage BAMv1 (orange).

1166 (B) Grayscale z-projection of ExR4, labeled by R14G09 > 10xUAS-mCD8::GFP. Z-projection  
1167 spans from the Gall (GA)/lateral accessory lobe (LAL) to the EB, and does not include the fan-  
1168 shaped body (FB) component of this driver (see below). ExR4 projects from the GA/LAL to EBop.

1169 (C) Single cell clone of ExR4; identified from the Flycircuit database (Chiang et al., 2011).

1170 (D-G) Top three rows of middle column corresponds to frontal sections of R14G09 > 10xUAS-  
1171 mCD8::GFP at three different antero-posterior depths (Refer to Supp. Movie 23). From top to  
1172 bottom: (D) anterior section containing the GA/LAL, (E) intermediate section containing the EB  
1173 and bulbs, (F) posterior section containing the FB and noduli. Bottom row (G; Refer to Supp.  
1174 Movie 24) is a horizontal section visualizing the length of the EB canal. R14G09-positive neurons  
1175 are shown in shown in green; neuropil is labeled with anti-DN-cadherin (magenta).

1176 (H-J) Corresponding sections in D-F using R14G09 labeled with the presynaptic marker syt.EGFP  
1177 (green) and dendritic marker DenMark (red). (H, I, J) Neuropil is labeled with anti-DN-cadherin  
1178 (gray). I' and J' show the isolated DenMark signal from I and J in white.

1179 Other abbreviations: AL, antennal lobe; AMMC, antenno-mechanosensory and motor center;  
1180 CRE, crepine; FBv, ventral region of the fan-shaped body; LEp, posterior component of the lateral  
1181 ellipsoid fascicle; loVM, medial component of the ventral longitudinal fascicle; SMP, superior  
1182 medial protocerebrum.

1183

1184

1185

1186

1187

1188

1189

1190

1191

1192

1193

1194

1195

1196

1197

1198

1199

1200

## Figure 7

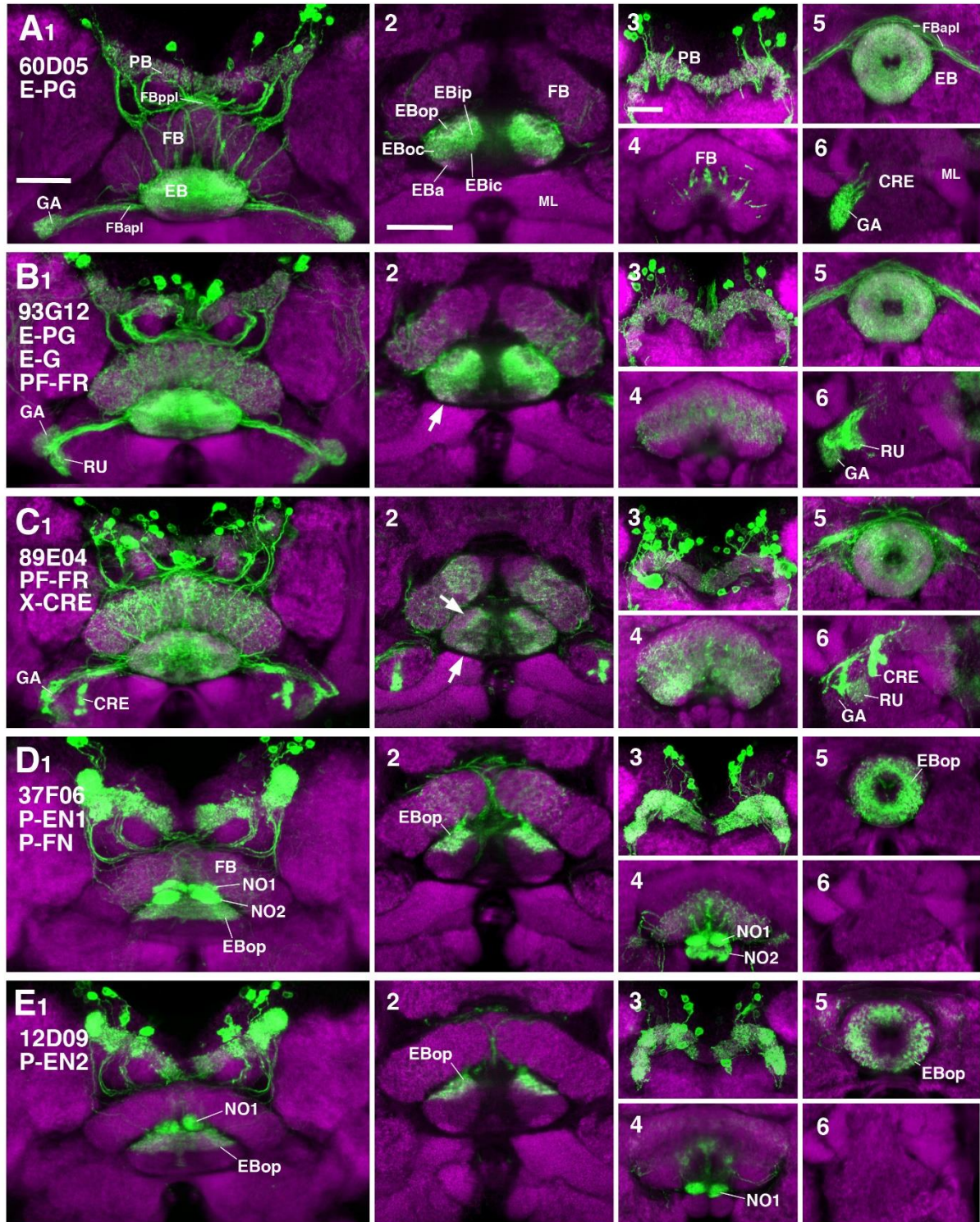

1201

1202 **Figure 7**

1203 CX innervation patterns of Gal4 drivers labeling columnar neuron populations

1204 (A-E) Confocal z-projections of Gal4 drivers that label columnar neuron classes. Each lettered,  
1205 six-paneled module corresponds to an individual driver labeled with 10xUAS-mCD8::GFP  
1206 (green); neuropil is labeled with anti-DN-cadherin (magenta). Left (1) is a z-projection from the  
1207 dorsal view spanning the antero-posterior depth of the brain (anterior pointing downward). Second  
1208 column (2) is a horizontal section visualizing the length of the EB canal; all five DN-cadherin  
1209 positive domains are visible. Final two columns (3-6) are four frontal sections of the CX and its  
1210 associated neuropils: (3) protocerebral bridge (PB), (4) fan-shaped body (FB), (5) ellipsoid body  
1211 (EB), (6) gall (GA)/lateral accessory lobe (LAL). Larger white annotations denote arborization-  
1212 containing domains of interest; smaller white annotations represent spatial landmarks.

1213 (A1-6) R60D05-Gal4 (E-PG neurons).

1214 (B1-6) R89E04-Gal4 (E-PG, “E-G”, “PF-FR” neurons). (2) Similar distribution of GFP signal as  
1215 E-PG neurons (A2), with additional innervation of EBa (arrow).

1216 (C1-6) R93G12-Gal4 [“PF-FR” neurons, “X-CRE” indicates a novel neuronal population with  
1217 glomerular endings in the crepine (CRE), dendritic terminals and their domains of innervation can  
1218 not be resolved]. (2) Ubiquitous innervation of the EB, with enriched signal in EBa and the anterior  
1219 border of EBop (arrows).

1220 (D1-6) R37F06-Gal4 (P-EN1, “P-FN” neurons). (2) EB innervation is restricted to outer posterior  
1221 domain (EBop).

1222 (E1-6) R12D09-Gal4 (P-EN2). (2) EB innervation is restricted to outer posterior domain (EBop).

1223 Other abbreviations: FBapl and FBppl, anterior and posterior plexus of the fan-shaped body; RU,  
1224 rubus.

1225

1226

1227

1228

1229

1230

1231

1232

1233

1234

1235

1236

## Figure 8

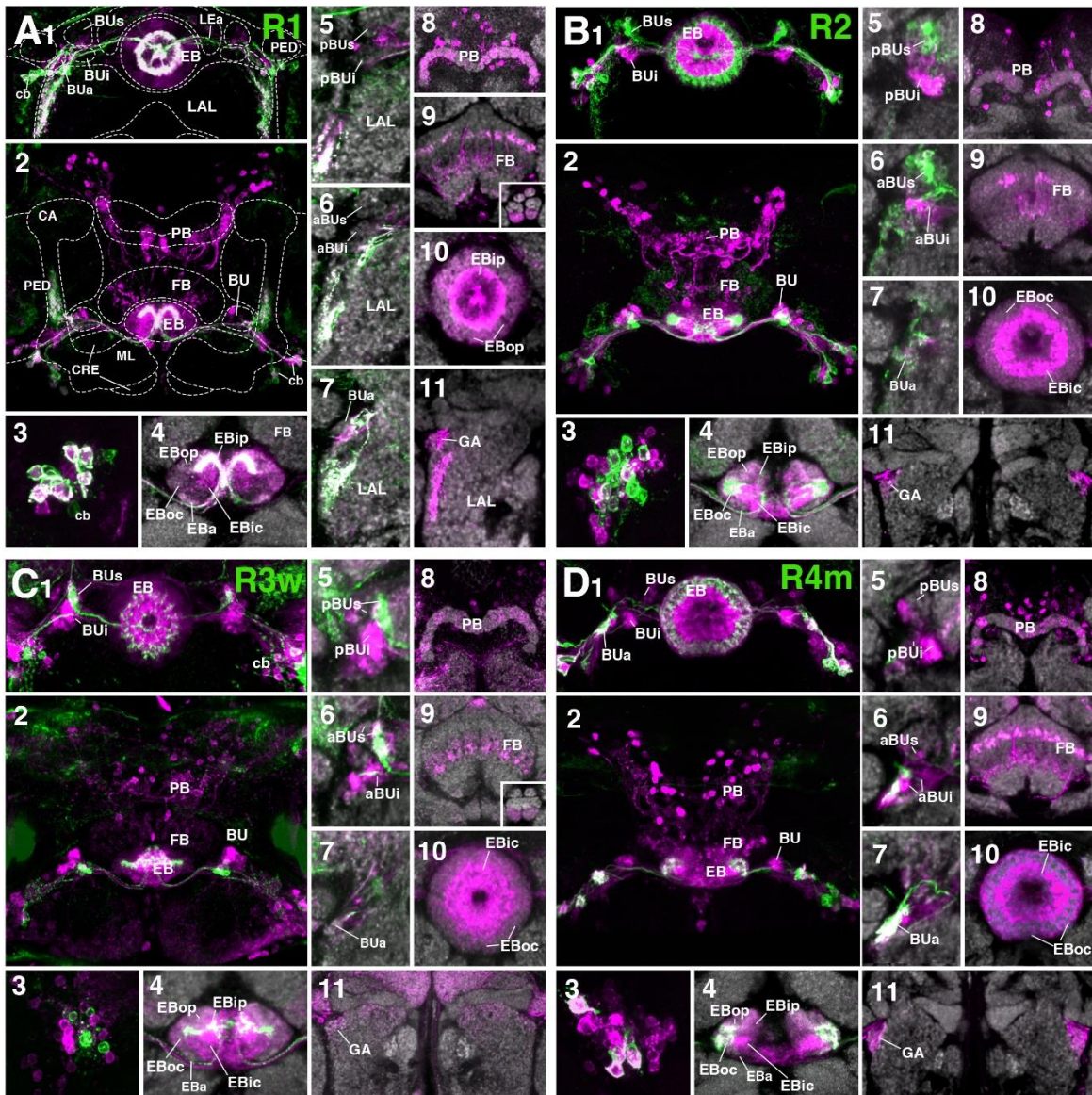

1237

### 1238 **Figure 8**

1239 Putative postsynaptic partners of R-neurons revealed by *trans*-Tango

1240 (A-D) Confocal z-projections of Gal4 drivers that label distinct R-neuron subclasses in conjunction  
 1241 with *trans*-Tango mediated labeling of postsynaptic neurons. Each lettered, eleven-paneled  
 1242 module corresponds to an individual driver. Gal4-expressing R-neurons labeled by GFP under  
 1243 UAS control (green), putative postsynaptic neurons are labeled by RFP under *trans*-Tango  
 1244 mediated QUAS control (magenta). Larger white annotations denote arborization-containing  
 1245 domains of interest; smaller white annotations represent spatial landmarks.

1246 Module organization outlined below:

1247 (1) Frontal z-projection spanning from R-neuron cell bodies to the ellipsoid body (EB)/bulbs (BU).

- 1248 (2) Z-projection from the dorsal view spanning the antero-posterior depth of the brain (anterior  
1249 pointing downward).
- 1250 (3) Cell body image to illustrate degree of colocalization between pre- and post-synaptic neurons,  
1251 an indication of homotypic interactions within a cell type.
- 1252 (4-11) Neuropil is labeled with anti-DN-cadherin (gray).
- 1253 (4) Horizontal section of the EB spanning the length of the EB canal.
- 1254 (5-7) Frontal sections of the bulb at three different depths. From top to bottom: (5) posterior section  
1255 containing the posterior regions of the superior (pBUs) and inferior (pBUi) bulb, (6) intermediate  
1256 section containing the anterior regions of the superior (aBUs) and inferior (aBUi) bulb, (7) anterior  
1257 section containing the anterior (BUa) bulb.
- 1258 (8-11) Isolated postsynaptic targets (shown in magenta) throughout the CX (Gal4-expressing  
1259 neurons are shown not shown). Four frontal sections of the CX and its associated neuropils; from  
1260 top (posterior-most) to bottom (anterior-most): (8) protocerebral bridge, (9) fan-shaped body, (10)  
1261 ellipsoid body, (11) gall (GA)/lateral accessory lobe (LAL).
- 1262 (A1-11) (R1) R31A12-Gal4 > *trans*-Tango
- 1263 (B1-11) (R2) R72B06-Gal4 > *trans*-Tango
- 1264 (C1-11) (R3w) VT057232-Gal4 > *trans*-Tango
- 1265 (D1-11) (R4m) R59B10-Gal4 > *trans*-Tango
- 1266 Other abbreviations: CRE, crepine; ML, PED, and CA, medial lobe, peduncle, and calyx of the  
1267 mushroom body, respectively; BUa, BUs, and BUi, anterior, superior, and inferior domains of the  
1268 bulb, respectively; anterior (EBa), inner central (EBic), outer central (EBoc), inner posterior  
1269 (EBip), and outer posterior (EBop) domains of the ellipsoid body; LEa, anterior component of the  
1270 lateral ellipsoid fascicle; cb, cell bodies.
- 1271
- 1272
- 1273
- 1274
- 1275
- 1276
- 1277
- 1278
- 1279

## Figure 9

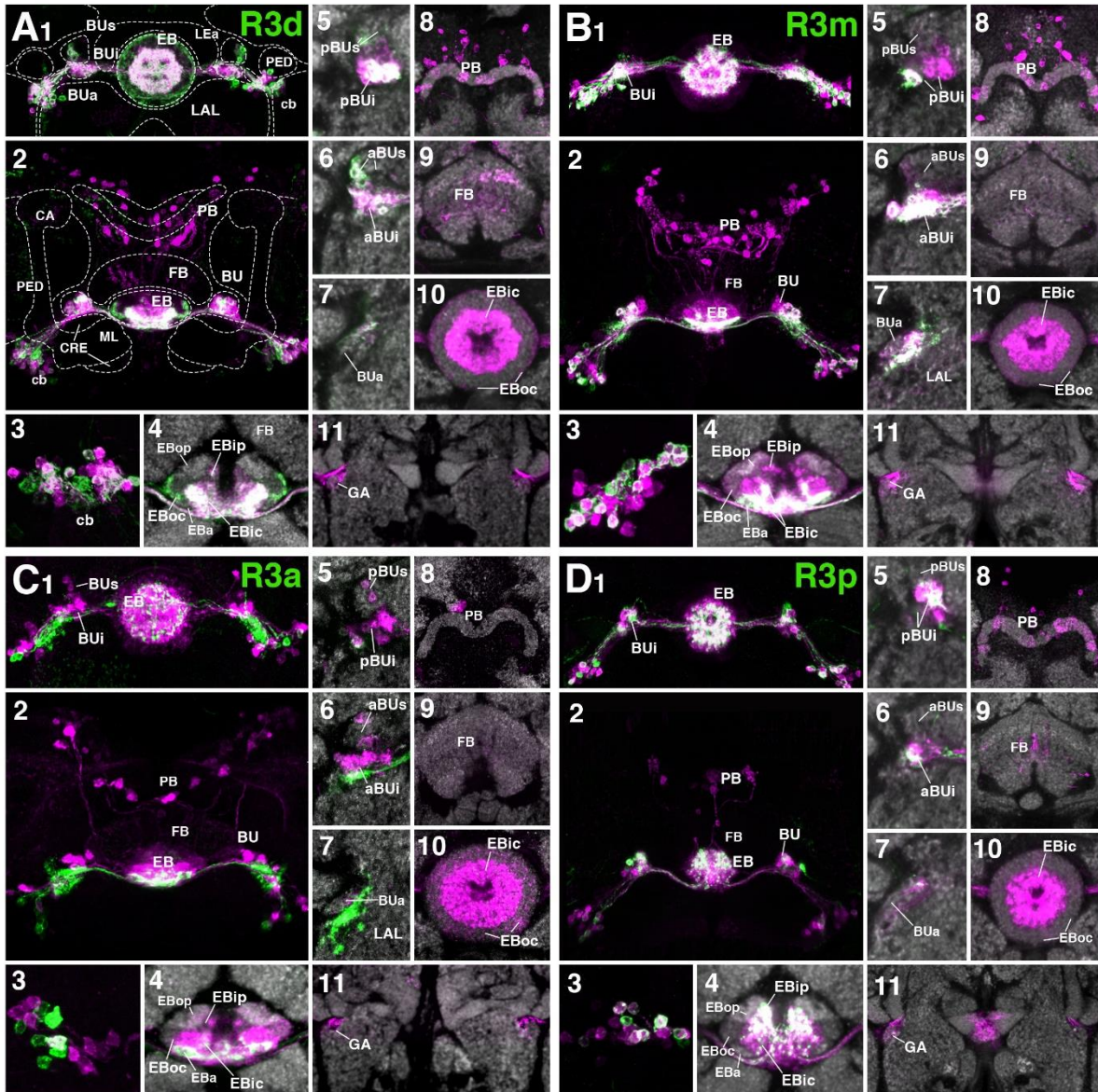

1280

1281 **Figure 9**

1282 Putative postsynaptic partners of R-neurons revealed by *trans*-Tango (cont.)

1283 (A-D) Similar modular format of panels as described in legend for Fig. 8.

1284 (A1-11) (R3d) R80C07-Gal4 > *trans*-Tango

1285 (B1-11) (R3m) R28E01-Gal4 > *trans*-Tango

1286 (C1-11) (R3a) R12G08-Gal4 > *trans*-Tango

1287 (D1-11) (R3p) VT063949-Gal4 > *trans*-Tango

1288 Other abbreviations: CRE, crepine; ML, PED, and CA, medial lobe, peduncle, and calyx of the  
1289 mushroom body, respectively; BUa, BUs, and BUi, anterior, superior, and inferior domains of the  
1290 bulb, respectively; anterior (EBa), inner central (EBic), outer central (EBoc), inner posterior  
1291 (EBip), and outer posterior (EBop) domains of the ellipsoid body; LEa, anterior component of the  
1292 lateral ellipsoid fascicle; cb, cell bodies.

1293

1294

1295

1296

1297

1298

1299

1300

1301

1302

1303

1304

1305

1306

1307

1308

1309

1310

1311

1312

1313

1314

1315

1316



**Figure 10**

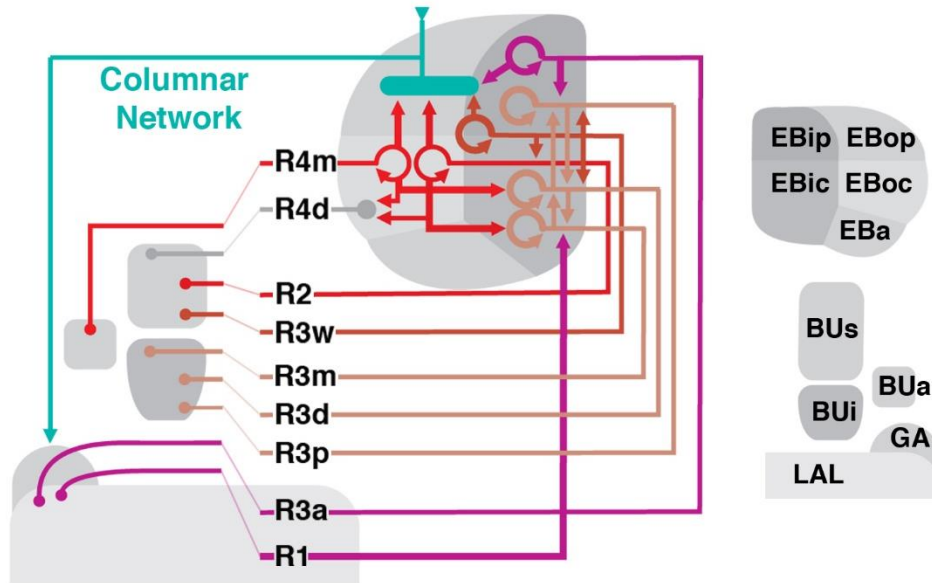

1317

1318 **Figure 10**

1319 Schematized overview of putative R-neuron interactions.

1320

1321

1322

1323

1324

1325

1326

1327

1328

1329

1330

1331

1332

1333

1334 **Author contribution statement**

1335 Conceptualization, JO; Methodology, JO, BN; Investigation, JO, BN, PK, JL; Writing – Original  
1336 Draft, JO, VH; Writing – Review and Editing, JO, BN, PK, JD, VH; Visualization, JO, BN, PK,  
1337 VH; Supervision and Funding Acquisition – JD, VH

1338 **Acknowledgments**

1339 We thank the Bloomington Stock Center and the Developmental Studies Hybridoma Bank for fly  
1340 strains and antibodies. We thank the following labs for kindly providing fly lines: lab of Gilad  
1341 Barnea for *trans*-Tango flies (Talay et al., 2017), Mark Frye for TPH-Gal4 (Park et al., 2006),  
1342 Heinrich Reichert for Poxn-Gal4 (Boll and Noll, 2002), and Barry Dickson for Vienna Tiles driver  
1343 lines (Tirian and Dickson, 2017). Images from FlyCircuit were obtained from the NCHC (National  
1344 Center for High-performance Computing) and NTHU (National Tsing Hua University), Hsinchu,  
1345 Taiwan. This work was supported by the NIH (grants R01 NS096290 to V.H. and R01NS105967  
1346 to J.M.D.), additional support provided by the University of California, Los Angeles Dissertation  
1347 Year Fellowship and the A.P. Giannini Postdoctoral Fellowship (to J.J.O.).

1348

1349

1350

1351

1352

1353

1354

1355

1356

1357

1358

1359

1360

1361

1362

1363

1364

1365 **References**

- 1366 Bayraktar, O. A., and Doe, C. Q. (2013). Combinatorial temporal patterning in progenitors expands  
1367 neural diversity. *Nature* 498, 449–455. doi:10.1038/nature12266.
- 1368 Bello, B. C., Izergina, N., Caussinus, E., and Reichert, H. (2008). Amplification of neural stem  
1369 cell proliferation by intermediate progenitor cells in Drosophila brain development. *Neural*  
1370 *Dev* 3, 5. doi:10.1186/1749-8104-3-5.
- 1371 Bender, J. A., Pollack, A. J., and Ritzmann, R. E. (2010). Neural activity in the central complex of  
1372 the insect brain is linked to locomotor changes. *Curr. Biol.* 20, 921–926.  
1373 doi:10.1016/j.cub.2010.03.054.
- 1374 Boll, W., and Noll, M. (2002). The Drosophila Pox neuro gene: control of male courtship behavior  
1375 and fertility as revealed by a complete dissection of all enhancers. *Development* 129, 5667–  
1376 5681.
- 1377 Boone, J. Q., and Doe, C. Q. (2008). Identification of Drosophila type II neuroblast lineages  
1378 containing transit amplifying ganglion mother cells. *Dev Neurobiol* 68, 1185–1195.  
1379 doi:10.1002/dneu.20648.
- 1380 Bowman, S. K., Rolland, V., Betschinger, J., Kinsey, K. A., Emery, G., and Knoblich, J. A. (2008).  
1381 The tumor suppressors Brat and Numb regulate transit-amplifying neuroblast lineages in  
1382 Drosophila. *Dev. Cell* 14, 535–546. doi:10.1016/j.devcel.2008.03.004.
- 1383 Boyan, G., Liu, Y., Khalsa, S. K., and Hartenstein, V. (2017). A conserved plan for wiring up the  
1384 fan-shaped body in the grasshopper and Drosophila. *Dev. Genes Evol.* 227, 253–269.  
1385 doi:10.1007/s00427-017-0587-2.
- 1386 Chiang, A.-S., Lin, C.-Y., Chuang, C.-C., Chang, H.-M., Hsieh, C.-H., Yeh, C.-W., et al. (2011).  
1387 Three-dimensional reconstruction of brain-wide wiring networks in Drosophila at single-cell  
1388 resolution. *Curr. Biol.* 21, 1–11. doi:10.1016/j.cub.2010.11.056.
- 1389 Costa, M., Manton, J. D., Ostrovsky, A. D., Prohaska, S., and Jefferis, G. S. X. E. (2016).  
1390 NBLAST: Rapid, Sensitive Comparison of Neuronal Structure and Construction of Neuron  
1391 Family Databases. *Neuron* 91, 293–311. doi:10.1016/j.neuron.2016.06.012.
- 1392 Doe, C. Q. (2017). Temporal Patterning in the Drosophila CNS. *Annu. Rev. Cell Dev. Biol.* 33,  
1393 219–240. doi:10.1146/annurev-cellbio-111315-125210.
- 1394 Donlea, J. M., Pimentel, D., Talbot, C. B., Kempf, A., Omoto, J. J., Hartenstein, V., et al. (2018).  
1395 Recurrent Circuitry for Balancing Sleep Need and Sleep. *Neuron* 97, 378–389.e4.  
1396 doi:10.1016/j.neuron.2017.12.016.
- 1397 Dus, M., Ai, M., and Suh, G. S. B. (2013). Taste-independent nutrient selection is mediated by a  
1398 brain-specific Na<sup>+</sup> /solute co-transporter in Drosophila. *Nat. Neurosci.* 16, 526–528.  
1399 doi:10.1038/nn.3372.

- 1400 Friggi-Grelin, F., Coulom, H., Meller, M., Gomez, D., Hirsh, J., and Birman, S. (2003). Targeted  
1401 gene expression in *Drosophila* dopaminergic cells using regulatory sequences from tyrosine  
1402 hydroxylase. *J. Neurobiol.* 54, 618–627. doi:10.1002/neu.10185.
- 1403 Gnerer, J. P., Venken, K. J. T., and Dierick, H. A. (2015). Gene-specific cell labeling using MiMIC  
1404 transposons. *Nucleic Acids Res.* 43, e56–e56. doi:10.1093/nar/gkv113.
- 1405 Green, J., Adachi, A., Shah, K. K., Hirokawa, J. D., Magani, P. S., and Maimon, G. (2017). A  
1406 neural circuit architecture for angular integration in *Drosophila*. *Nature* 546, 101–106.  
1407 doi:10.1038/nature22343.
- 1408 Guo, P., and Ritzmann, R. E. (2013). Neural activity in the central complex of the cockroach brain  
1409 is linked to turning behaviors. *J. Exp. Biol.* 216, 992–1002. doi:10.1242/jeb.080473.
- 1410 Hadeln, von, J., Althaus, V., Häger, L., and Homberg, U. (2018). Anatomical organization of the  
1411 cerebrum of the desert locust *Schistocerca gregaria*. *Cell Tissue Res.* 178, 199–24.  
1412 doi:10.1007/s00441-018-2844-8.
- 1413 Hanesch, U., Fischbach, K. F., and Heisenberg, M. (1989). Neuronal Architecture of the Central  
1414 Complex in *Drosophila-Melanogaster*. *Cell Tissue Res.* 257, 343–366.  
1415 doi:10.1007/BF00261838.
- 1416 Hartenstein, V., Cruz, L., Lovick, J. K., and Guo, M. (2017). Developmental analysis of the  
1417 dopamine-containing neurons of the *Drosophila* brain. *J. Comp. Neurol.* 525, 363–379.  
1418 doi:10.1002/cne.24069.
- 1419 Heinze, S. (2017). Unraveling the neural basis of insect navigation. *Curr Opin Insect Sci* 24, 58–  
1420 67. doi:10.1016/j.cois.2017.09.001.
- 1421 Heinze, S., and Homberg, U. (2007). Maplike representation of celestial E-vector orientations in  
1422 the brain of an insect. *Science* 315, 995–997. doi:10.1126/science.1135531.
- 1423 Heinze, S., and Reppert, S. M. (2011). Sun compass integration of skylight cues in migratory  
1424 monarch butterflies. *Neuron* 69, 345–358. doi:10.1016/j.neuron.2010.12.025.
- 1425 Heinze, S., and Reppert, S. M. (2012). Anatomical basis of sun compass navigation I: the general  
1426 layout of the monarch butterfly brain. *J. Comp. Neurol.* 520, 1599–1628.  
1427 doi:10.1002/cne.23054.
- 1428 Immonen, E.-V., Dacke, M., Heinze, S., and Jundi, el, B. (2017). Anatomical organization of the  
1429 brain of a diurnal and a nocturnal dung beetle. *J. Comp. Neurol.* 525, 1879–1908.  
1430 doi:10.1002/cne.24169.
- 1431 Ito, K., and Awasaki, T. (2008). “Clonal Unit Architecture of the Adult Fly Brain,” in *Brain*  
1432 *Development in Drosophila melanogaster* Advances in Experimental Medicine and Biology.  
1433 (New York, NY: Springer, New York, NY), 137–158. doi:10.1007/978-0-387-78261-4\_9.
- 1434 Ito, K., Shinomiya, K., Ito, M., Armstrong, J. D., Boyan, G., Hartenstein, V., et al. (2014). A

- 1435 systematic nomenclature for the insect brain. *Neuron* 81, 755–765.  
1436 doi:10.1016/j.neuron.2013.12.017.
- 1437 Ito, M., Masuda, N., Shinomiya, K., Endo, K., and Ito, K. (2013). Systematic analysis of neural  
1438 projections reveals clonal composition of the *Drosophila* brain. *Curr. Biol.* 23, 644–655.  
1439 doi:10.1016/j.cub.2013.03.015.
- 1440 Jenett, A., Rubin, G. M., Ngo, T.-T. B., Shepherd, D., Murphy, C., Dionne, H., et al. (2012). A  
1441 GAL4-driver line resource for *Drosophila* neurobiology. *Cell Rep* 2, 991–1001.  
1442 doi:10.1016/j.celrep.2012.09.011.
- 1443 Jundi, el, B., Pfeiffer, K., Heinze, S., and Homberg, U. (2014). Integration of polarization and  
1444 chromatic cues in the insect sky compass. *J. Comp. Physiol. A Neuroethol. Sens. Neural.*  
1445 *Behav. Physiol.* 200, 575–589. doi:10.1007/s00359-014-0890-6.
- 1446 Jundi, el, B., Warrant, E. J., Byrne, M. J., Khaldy, L., Baird, E., Smolka, J., et al. (2015). Neural  
1447 coding underlying the cue preference for celestial orientation. *Proc. Natl. Acad. Sci. U.S.A.*  
1448 112, 11395–11400. doi:10.1073/pnas.1501272112.
- 1449 Kumar, A., Bello, B., Reichert, H. (2009) Lineage-specific cell death in postembryonic brain  
1450 development of *Drosophila*. *Development* 136, 3433–3442. doi: 10.1242/dev.037226.
- 1451 Kuntz, S., Poeck, B., Sokolowski, M. B., and Strauss, R. (2012). The visual orientation memory  
1452 of *Drosophila* requires Foraging (PKG) upstream of Ignorant (RSK2) in ring neurons of the  
1453 central complex. *Learn. Mem.* 19, 337–340. doi:10.1101/lm.026369.112.
- 1454 Larsen, C., Shy, D., Spindler, S. R., Fung, S., Peraanu, W., Younossi-Hartenstein, A., et al. (2009).  
1455 Patterns of growth, axonal extension and axonal arborization of neuronal lineages in the  
1456 developing *Drosophila* brain. *Dev. Biol.* 335, 289–304. doi:10.1016/j.ydbio.2009.06.015.
- 1457 Lee, T., and Luo, L. (1999). Mosaic Analysis with a Repressible Cell Marker for Studies of Gene  
1458 Function in Neuronal Morphogenesis. *Neuron* 22, 451–461. doi:10.1016/S0896-  
1459 6273(00)80701-1.
- 1460 Lin, C.-Y., Chuang, C.-C., Hua, T.-E., Chen, C.-C., Dickson, B. J., Greenspan, R. J., et al. (2013).  
1461 A comprehensive wiring diagram of the protocerebral bridge for visual information processing  
1462 in the *Drosophila* brain. *Cell Rep* 3, 1739–1753. doi:10.1016/j.celrep.2013.04.022.
- 1463 Liu, Q., Tabuchi, M., Liu, S., Kodama, L., Horiuchi, W., Daniels, J., et al. (2017). Branch-specific  
1464 plasticity of a bifunctional dopamine circuit encodes protein hunger. *Science* 356, 534–539.  
1465 doi:10.1126/science.aal3245.
- 1466 Liu, S., Liu, Q., Tabuchi, M., and Wu, M. N. (2016). Sleep Drive Is Encoded by Neural Plastic  
1467 Changes in a Dedicated Circuit. *Cell* 165, 1347–1360. doi:10.1016/j.cell.2016.04.013.
- 1468 Lovick, J. K., and Hartenstein, V. (2015). Hydroxyurea-mediated neuroblast ablation establishes  
1469 birth dates of secondary lineages and addresses neuronal interactions in the developing  
1470 *Drosophila* brain. *Dev. Biol.* 402, 32–47. doi:10.1016/j.ydbio.2015.03.005.

- 1471 Lovick, J. K., Ngo, K. T., Omoto, J. J., Wong, D. C., Nguyen, J. D., and Hartenstein, V. (2013).  
1472 Postembryonic lineages of the *Drosophila* brain: I. Development of the lineage-associated  
1473 fiber tracts. *Dev. Biol.* 384, 228–257. doi:10.1016/j.ydbio.2013.07.008.
- 1474 Lovick, J. K., Omoto, J. J., Ngo, K. T., and Hartenstein, V. (2017). Development of the anterior  
1475 visual input pathway to the *Drosophila* central complex. *J. Comp. Neurol.* 525, 3458–3475.  
1476 doi:10.1002/cne.24277.
- 1477 Martin, J. P., Guo, P., Mu, L., Harley, C. M., and Ritzmann, R. E. (2015). Central-complex control  
1478 of movement in the freely walking cockroach. *Curr. Biol.* 25, 2795–2803.  
1479 doi:10.1016/j.cub.2015.09.044.
- 1480 Martin, J. R., Raabe, T., and Heisenberg, M. (1999). Central complex substructures are required  
1481 for the maintenance of locomotor activity in *Drosophila melanogaster*. *J Comp Physiol A* 185,  
1482 277–288. doi:10.1007/s003590050387.
- 1483 Martín-Peña, A., Acebes, A., Rodriguez, J. R., Chevalier, V., Casas-Tinto, S., Triphan, T., Strauss,  
1484 R., Ferrús, A. (2014). Cell types and coincident synapses in the ellipsoid body of *Drosophila*.  
1485 *Eur J Neurosci.* 39, 1586–1601. doi: 10.1111/ejn.12537.
- 1486 Minocha, S., Boll, W., and Noll, M. (2017). Crucial roles of Pox neuro in the developing ellipsoid  
1487 body and antennal lobes of the *Drosophila* brain. *PLoS ONE* 12, e0176002.  
1488 doi:10.1371/journal.pone.0176002.
- 1489 Müller, M., Homberg, U., and Kühn, A. (1997). Neuroarchitecture of the lower division of the  
1490 central body in the brain of the locust (*Schistocerca gregaria*). *Cell Tissue Res.* 288, 159–176.
- 1491 Namiki, S., and Kanzaki, R. (2016). Comparative Neuroanatomy of the Lateral Accessory Lobe  
1492 in the Insect Brain. *Front Physiol* 7, 244. doi:10.3389/fphys.2016.00244.
- 1493 Nern, A., Pfeiffer, B. D., and Rubin, G. M. (2015). Optimized tools for multicolor stochastic  
1494 labeling reveal diverse stereotyped cell arrangements in the fly visual system. *Proc. Natl.*  
1495 *Acad. Sci. U.S.A.* 112, E2967–76. doi:10.1073/pnas.1506763112.
- 1496 Neuser, K., Triphan, T., Mronz, M., Poeck, B., and Strauss, R. (2008). Analysis of a spatial  
1497 orientation memory in *Drosophila*. *Nature* 453, 1244–1247. doi:10.1038/nature07003.
- 1498 Nicolai, L. J. J., Ramaekers, A., Raemaekers, T., Drozdzecki, A., Mauss, A. S., Yan, J., et al.  
1499 (2010). Genetically encoded dendritic marker sheds light on neuronal connectivity in  
1500 *Drosophila*. *Proc. Natl. Acad. Sci. U.S.A.* 107, 20553–20558. doi:10.1073/pnas.1010198107.
- 1501 Ofstad, T. A., Zuker, C. S., and Reiser, M. B. (2011). Visual place learning in *Drosophila*  
1502 *melanogaster*. *Nature* 474, 204–207. doi:10.1038/nature10131.
- 1503 Omoto, J. J., Keleş, M. F., Nguyen, B.-C. M., Bolanos, C., Lovick, J. K., Frye, M. A., et al. (2017).  
1504 Visual Input to the *Drosophila* Central Complex by Developmentally and Functionally  
1505 Distinct Neuronal Populations. *Curr. Biol.* 27, 1098–1110. doi:10.1016/j.cub.2017.02.063.

- 1506 Park, J., Lee, S. B., Lee, S., Kim, Y., Song, S., Kim, S., et al. (2006). Mitochondrial dysfunction  
1507 in *Drosophila* PINK1 mutants is complemented by parkin. *Nature* 441, 1157–1161.  
1508 doi:10.1038/nature04788.
- 1509 Park, J.-Y., Dus, M., Kim, S., Abu, F., Kanai, M. I., Rudy, B., et al. (2016). *Drosophila* SLC5A11  
1510 Mediates Hunger by Regulating K(+) Channel Activity. *Curr. Biol.* 26, 1965–1974.  
1511 doi:10.1016/j.cub.2016.05.076.
- 1512 Pereanu, W., and Hartenstein, V. (2006). Neural lineages of the *Drosophila* brain: a three-  
1513 dimensional digital atlas of the pattern of lineage location and projection at the late larval  
1514 stage. *J. Neurosci.* 26, 5534–5553. doi:10.1523/JNEUROSCI.4708-05.2006.
- 1515 Pereanu, W., Kumar, A., Jennett, A., Reichert, H., and Hartenstein, V. (2010). Development-based  
1516 compartmentalization of the *Drosophila* central brain. *J. Comp. Neurol.* 518, 2996–3023.  
1517 doi:10.1002/cne.22376.
- 1518 Pfeiffer, K., and Homberg, U. (2014). Organization and functional roles of the central complex in  
1519 the insect brain. *Annu. Rev. Entomol.* 59, 165–184. doi:10.1146/annurev-ento-011613-  
1520 162031.
- 1521 Pooryasin, A., and Fiala, A. (2015). Identified Serotonin-Releasing Neurons Induce Behavioral  
1522 Quiescence and Suppress Mating in *Drosophila*. *J. Neurosci.* 35, 12792–12812.  
1523 doi:10.1523/JNEUROSCI.1638-15.2015.
- 1524 Ren, Q., Awasaki, T., Huang, Y.-F., Liu, Z., and Lee, T. (2016). Cell Class-Lineage Analysis  
1525 Reveals Sexually Dimorphic Lineage Compositions in the *Drosophila* Brain. *Curr. Biol.* 26,  
1526 2583–2593. doi:10.1016/j.cub.2016.07.086.
- 1527 Renn, S. C., Armstrong, J. D., Yang, M., Wang, Z., An, X., Kaiser, K., et al. (1999). Genetic  
1528 analysis of the *Drosophila* ellipsoid body neuropil: organization and development of the  
1529 central complex. *J. Neurobiol.* 41, 189–207.
- 1530 Rieche, F., Carmine-Simmen, K., Poeck, B., Kretzschmar, D., and Strauss, R. (2018). *Drosophila*  
1531 Full-Length Amyloid Precursor Protein Is Required for Visual Working Memory and Prevents  
1532 Age-Related Memory Impairment. *Curr. Biol.* 28, 817–823.e3.  
1533 doi:10.1016/j.cub.2018.01.077.
- 1534 Schindelin, J., Arganda-Carreras, I., Frise, E., Kaynig, V., Longair, M., Pietzsch, T., et al. (2012).  
1535 Fiji: an open-source platform for biological-image analysis. *Nat. Methods* 9, 676–682.  
1536 doi:10.1038/nmeth.2019.
- 1537 Seelig, J. D., and Jayaraman, V. (2013). Feature detection and orientation tuning in the *Drosophila*  
1538 central complex. *Nature* 503, 262–266. doi:10.1038/nature12601.
- 1539 Seelig, J. D., and Jayaraman, V. (2015). Neural dynamics for landmark orientation and angular  
1540 path integration. *Nature* 521, 186–191. doi:10.1038/nature14446.
- 1541 Shiozaki, H. M., and Kazama, H. (2017). Parallel encoding of recent visual experience and self-

- 1542 motion during navigation in *Drosophila*. *Nat. Neurosci.* 20, 1395–1403. doi:10.1038/nn.4628.
- 1543 Spindler, S. R., and Hartenstein, V. (2010). The *Drosophila* neural lineages: a model system to  
1544 study brain development and circuitry. *Dev. Genes Evol.* 220, 1–10. doi:10.1007/s00427-010-  
1545 0323-7.
- 1546 Spindler, S. R., and Hartenstein, V. (2011). Bazooka mediates secondary axon morphology in  
1547 *Drosophila* brain lineages. *Neural Dev* 6, 16. doi:10.1186/1749-8104-6-16.
- 1548 Strausfeld, N. J. (2012). *Atlas of an Insect Brain*. ed.N. J. Strausfeld Berlin, Heidelberg: Springer  
1549 Science & Business Media doi:10.1007/978-3-642-66179-2.
- 1550 Strauss, R., and HEISENBERG, M. (1993). A higher control center of locomotor behavior in the  
1551 *Drosophila* brain. *J. Neurosci.* 13, 1852–1861. doi:10.1523/JNEUROSCI.13-05-01852.1993.
- 1552 Sun, Y., Nern, A., Franconville, R., Dana, H., Schreiter, E. R., Looger, L. L., et al. (2017). Neural  
1553 signatures of dynamic stimulus selection in *Drosophila*. *Nat. Neurosci.* 20, 1104–1113.  
1554 doi:10.1038/nn.4581.
- 1555 Talay, M., Richman, E. B., Snell, N. J., Hartmann, G. G., Fisher, J. D., Sorkaç, A., et al. (2017).  
1556 Transsynaptic Mapping of Second-Order Taste Neurons in Flies by trans-Tango. *Neuron* 96,  
1557 783–795.e4. doi:10.1016/j.neuron.2017.10.011.
- 1558 Thran, J., Poeck, B., and Strauss, R. (2013). Serum response factor-mediated gene regulation in a  
1559 *Drosophila* visual working memory. *Curr. Biol.* 23, 1756–1763.  
1560 doi:10.1016/j.cub.2013.07.034.
- 1561 Tirian, L., and Dickson, B. (2017). The VT GAL4, LexA, and split-GAL4 driver line collections  
1562 for targeted expression in the *Drosophila* nervous system. *bioRxiv*, 198648.  
1563 doi:10.1101/198648.
- 1564 Turner-Evans, D., Wegener, S., Rouault, H., Franconville, R., Wolff, T., Seelig, J. D., et al. (2017).  
1565 Angular velocity integration in a fly heading circuit. *Elife* 6, e04577. doi:10.7554/eLife.23496.
- 1566 Varga, A. G., and Ritzmann, R. E. (2016). Cellular Basis of Head Direction and Contextual Cues  
1567 in the Insect Brain. *Current Biology* 26, 1816–1828. doi:10.1016/j.cub.2016.05.037.
- 1568 Wang, Y.-C., Yang, J. S., Johnston, R., Ren, Q., Lee, Y.-J., Luan, H., et al. (2014). *Drosophila*  
1569 intermediate neural progenitors produce lineage-dependent related series of diverse neurons.  
1570 *Development* 141, 253–258. doi:10.1242/dev.103069.
- 1571 Wolff, T., Iyer, N. A., and Rubin, G. M. (2015). Neuroarchitecture and neuroanatomy of the  
1572 *Drosophila* central complex: A GAL4-based dissection of protocerebral bridge neurons and  
1573 circuits. *J. Comp. Neurol.* 523, 997–1037. doi:10.1002/cne.23705.
- 1574 Wong, D. C., Lovick, J. K., Ngo, K. T., Borisuthirattana, W., Omoto, J. J., and Hartenstein, V.  
1575 (2013). Postembryonic lineages of the *Drosophila* brain: II. Identification of lineage projection  
1576 patterns based on MARCM clones. *Dev. Biol.* 384, 258–289.



- 1577        doi:10.1016/j.ydbio.2013.07.009.
- 1578        Xie, X., Tabuchi, M., Brown, M. P., Mitchell, S. P., Wu, M. N., and Kolodkin, A. L. (2017). The  
1579        laminar organization of the *Drosophila* ellipsoid body is semaphorin-dependent and prevents  
1580        the formation of ectopic synaptic connections. *Elife* 6, e04577. doi:10.7554/eLife.25328.
- 1581        Yang, J. S., Awasaki, T., Yu, H.-H., He, Y., Ding, P., Kao, J.-C., et al. (2013). Diverse neuronal  
1582        lineages make stereotyped contributions to the *Drosophila* locomotor control center, the  
1583        central complex. *J. Comp. Neurol.* 521, 2645–Spc1. doi:10.1002/cne.23339.
- 1584        Young, J. M., and Armstrong, J. D. (2010a). Building the central complex in *Drosophila*: the  
1585        generation and development of distinct neural subsets. *J. Comp. Neurol.* 518, 1525–1541.  
1586        doi:10.1002/cne.22285.
- 1587        Young, J. M., and Armstrong, J. D. (2010b). Structure of the adult central complex in *Drosophila*:  
1588        organization of distinct neuronal subsets. *J. Comp. Neurol.* 518, 1500–1524.  
1589        doi:10.1002/cne.22284.
- 1590        Yu, H.-H., Awasaki, T., Schroeder, M. D., Long, F., Yang, J. S., He, Y., et al. (2013). Clonal  
1591        development and organization of the adult *Drosophila* central brain. *Curr. Biol.* 23, 633–643.  
1592        doi:10.1016/j.cub.2013.02.057.
- 1593        Zhao, X., Lenek, D., Dag, U., Dickson, B. J., and Keleman, K. (2018). Persistent activity in a  
1594        recurrent circuit underlies courtship memory in *Drosophila*. *Elife* 7, e04577.  
1595        doi:10.7554/eLife.31425.
- 1596        Zheng, Z., Lauritzen, J. S., Perlman, E., Robinson, C. G., Nichols, M., Milkie, D., et al. (2018). A  
1597        Complete Electron Microscopy Volume of the Brain of Adult *Drosophila melanogaster*. *Cell*  
1598        174, 730–743.e22. doi:10.1016/j.cell.2018.06.019.
- 1599