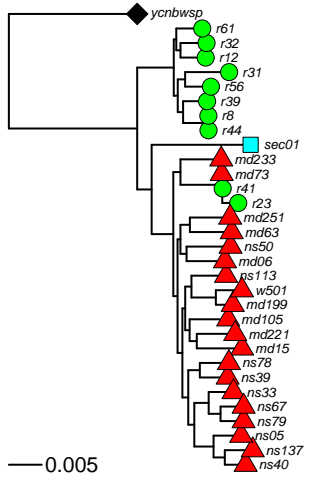

Figure S1

2L:15150000–15260000



2L:1810000–1830000



2L:2790000–2860000

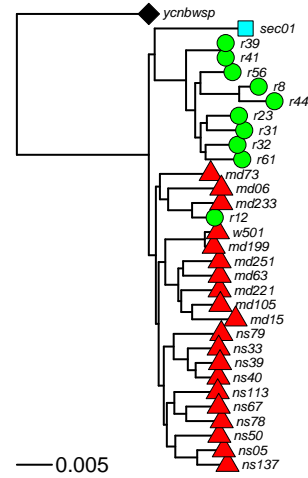

2L:9040000–9050000

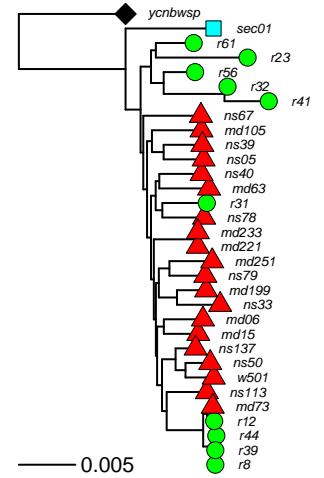

2R:13700000–13710000

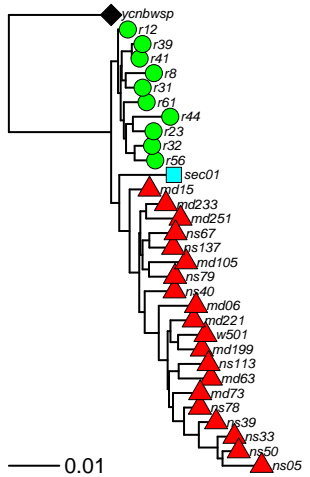

2R:3760000–3790000

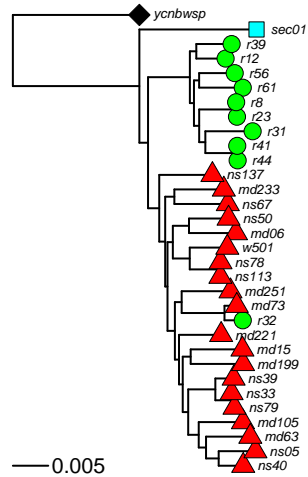

3L:20760000–20910000

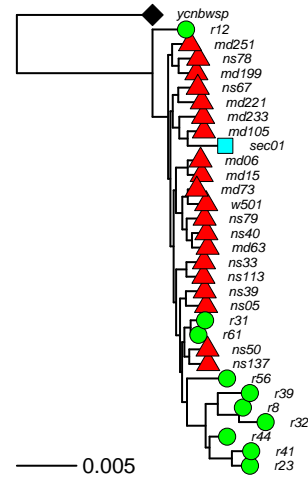

3L:21220000–21450000

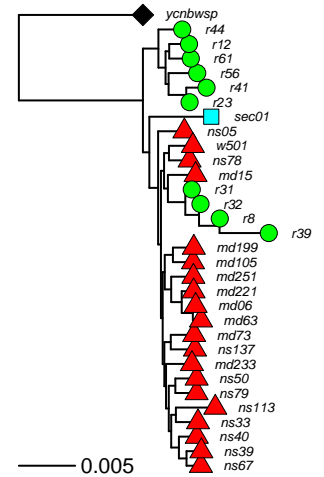
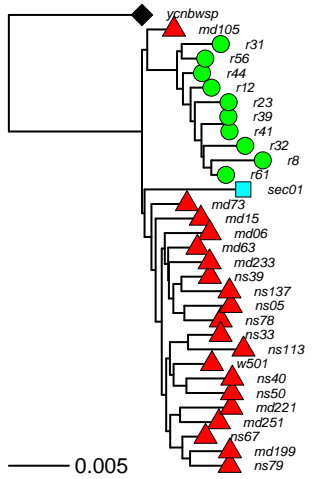
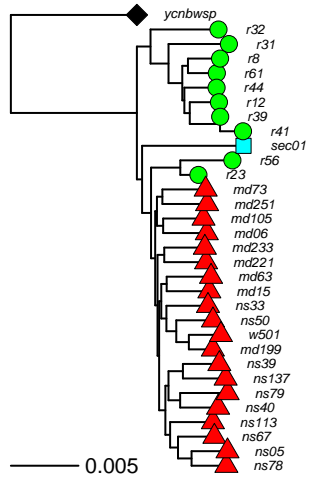

Figure S2

3R:13620000-13630000



3R:13870000-14070000



3R:21470000-21480000

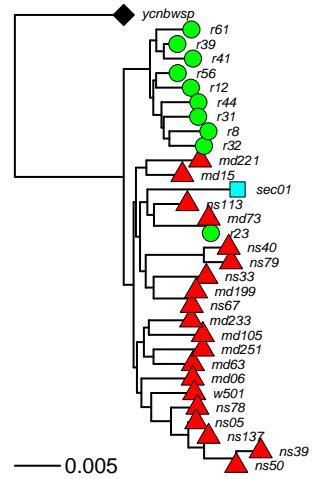

3R:21530000-21670000

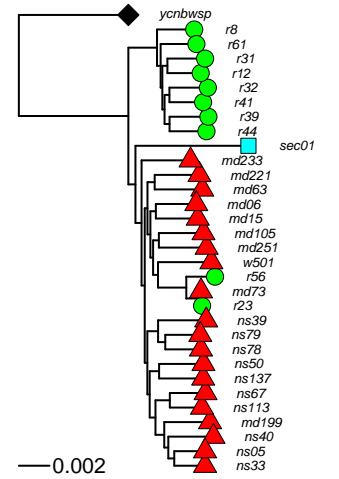

3R:23350000-23420000

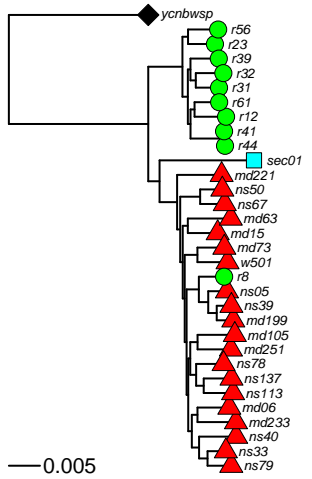

3R:23730000-23740000

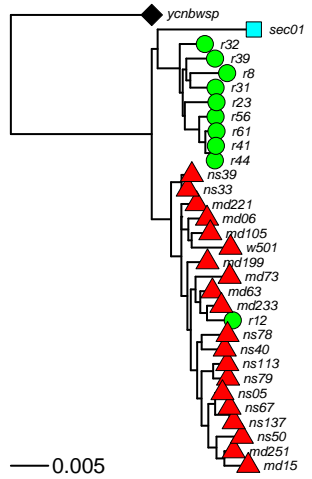

3R:23980000-24020000

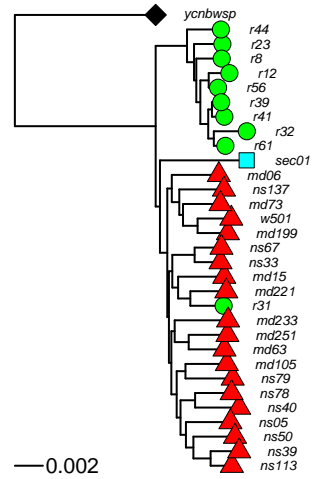

3R:24100000-24120000

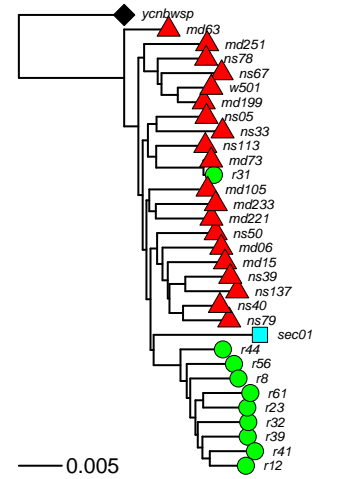
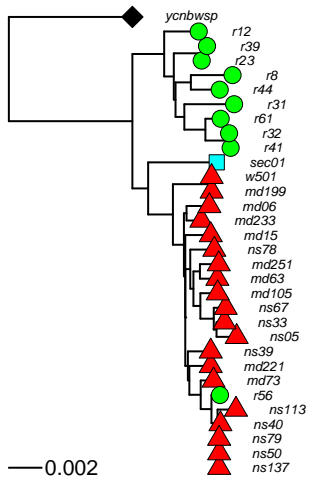
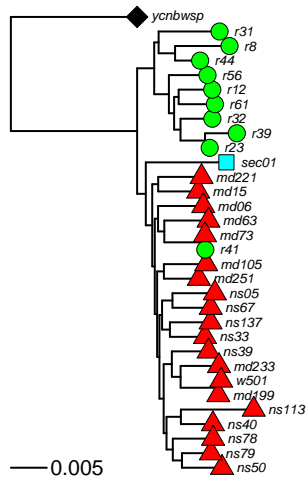

Figure S2

3R:3350000–3360000



3R:4570000–4680000



3R:5020000–5070000

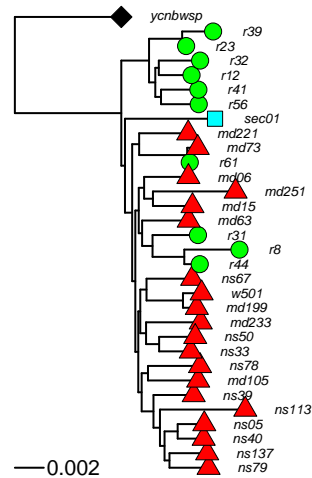

X:8560000–8580000

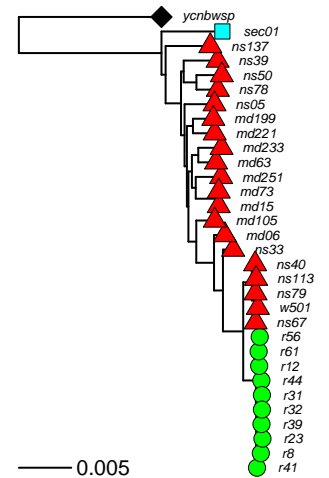

X:8630000–8690000

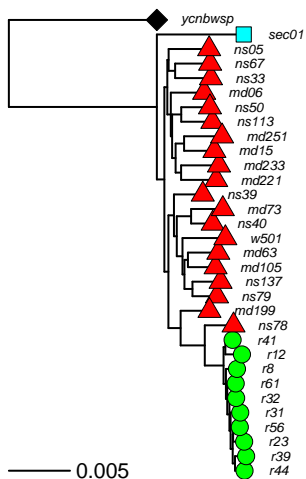

Figure S2

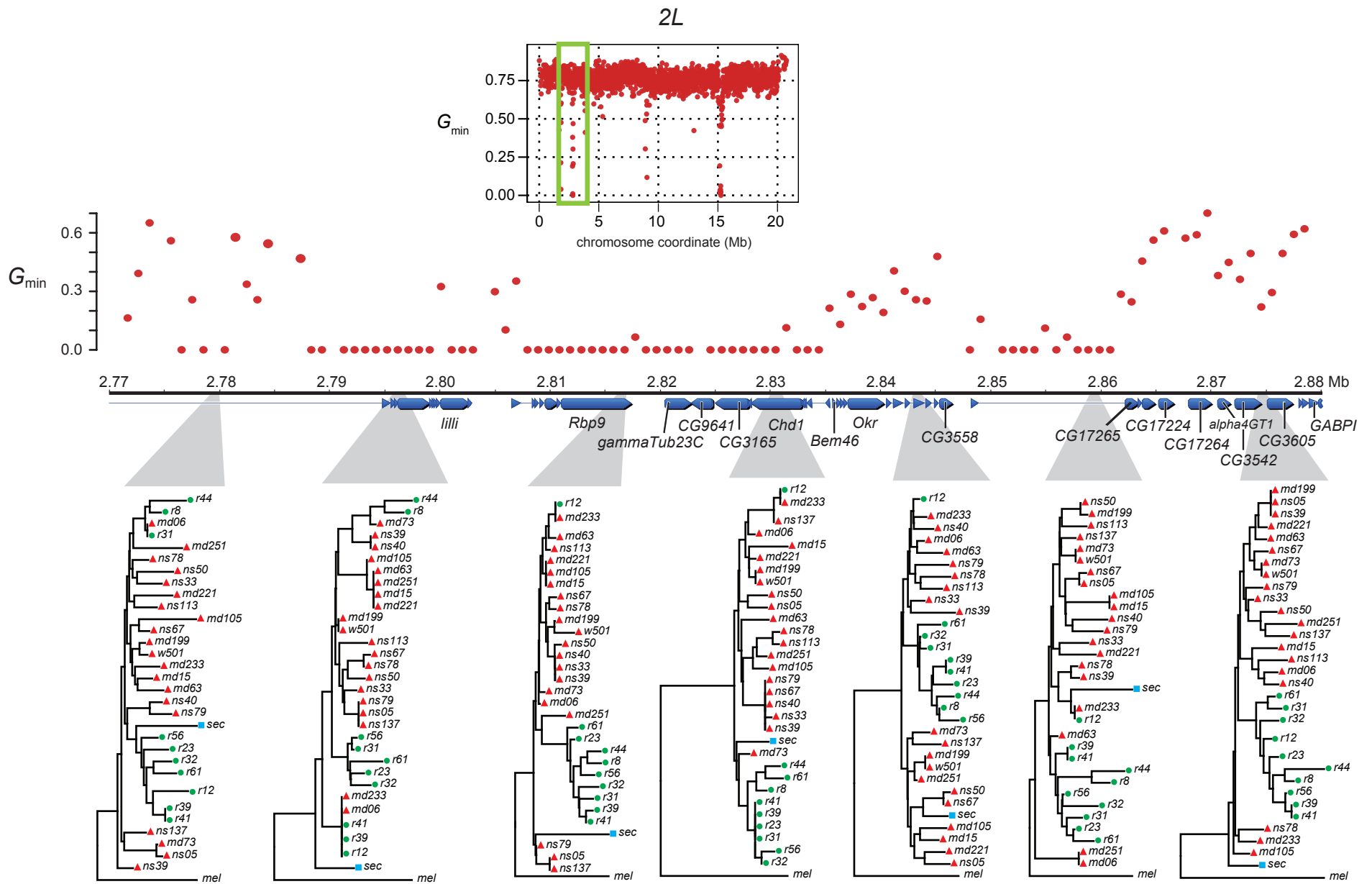
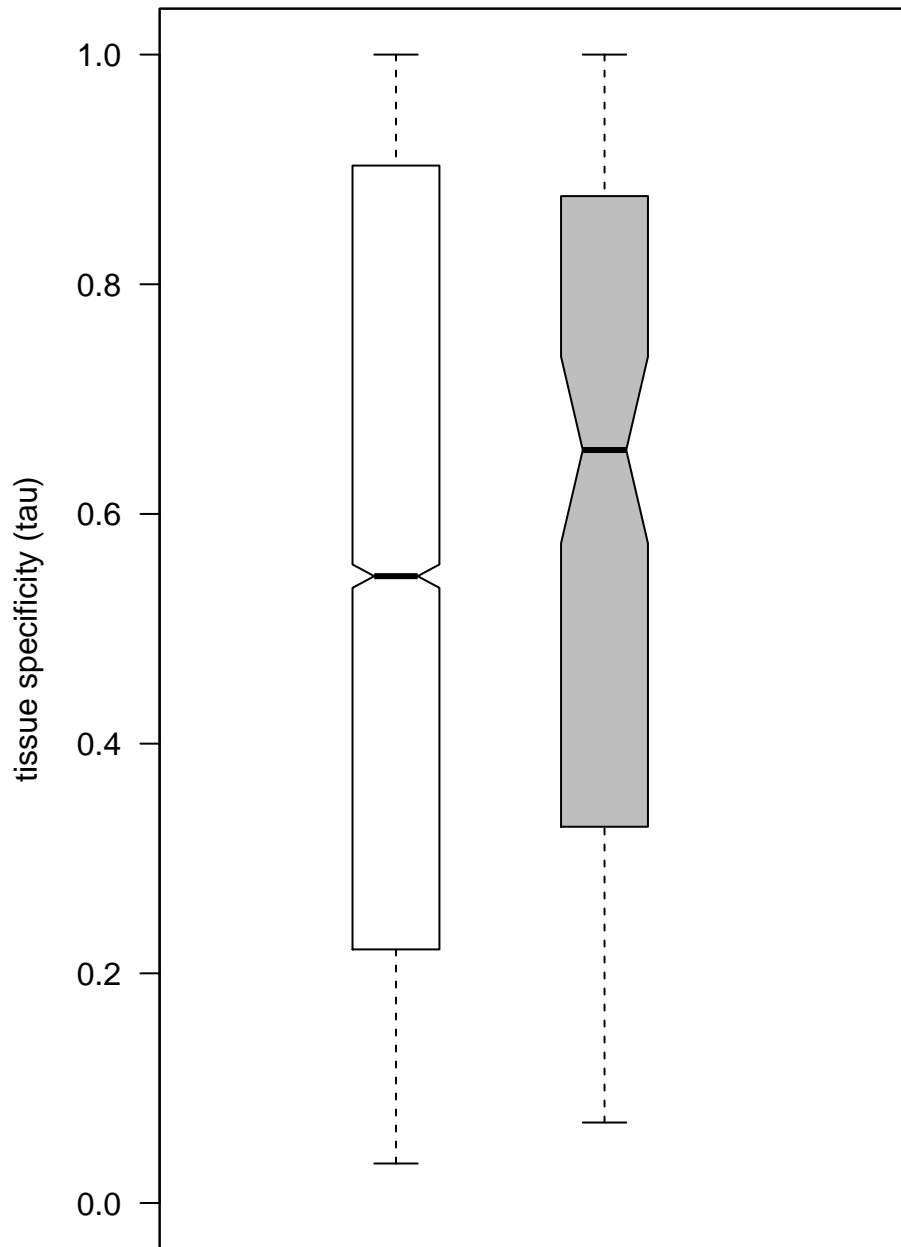

Figure S3

all genes



testes-specific genes excluded

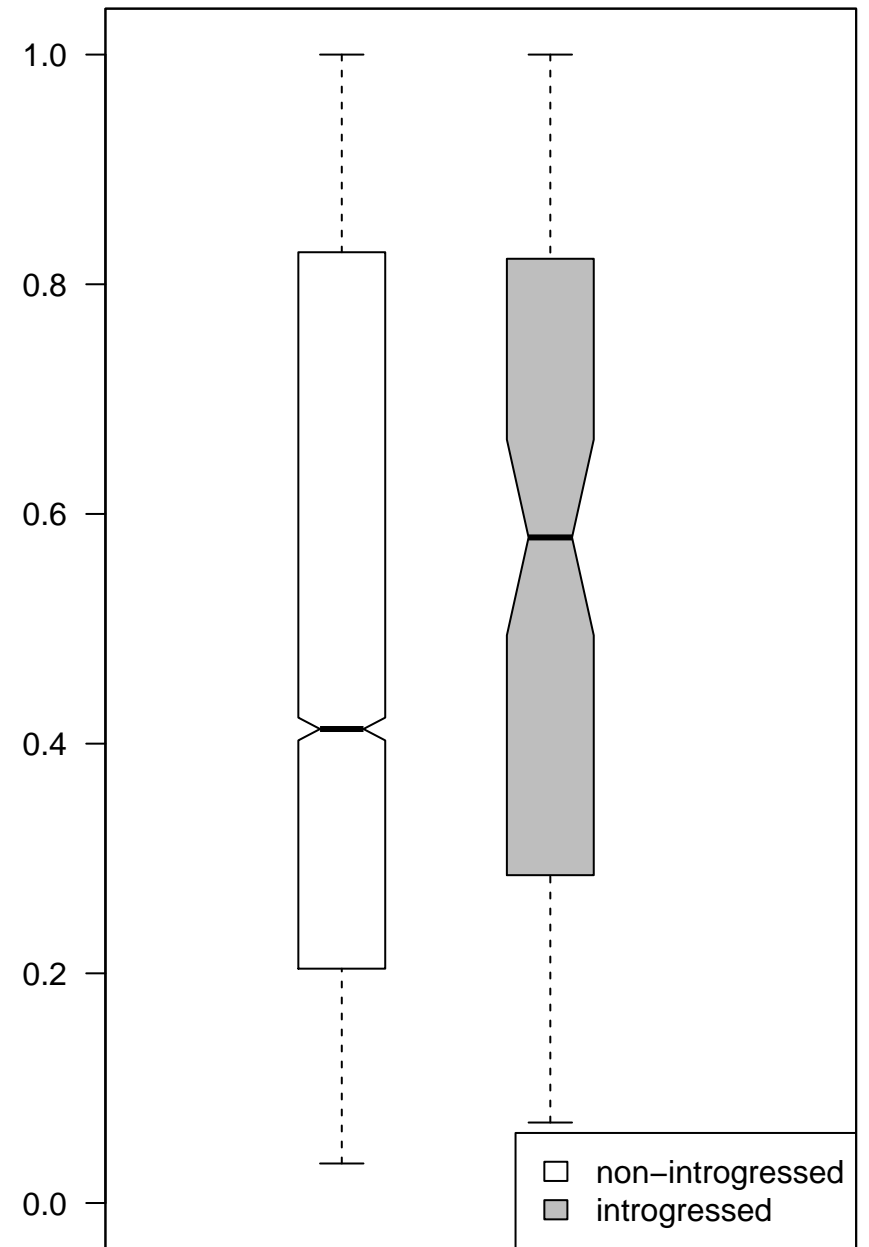

Figure S4

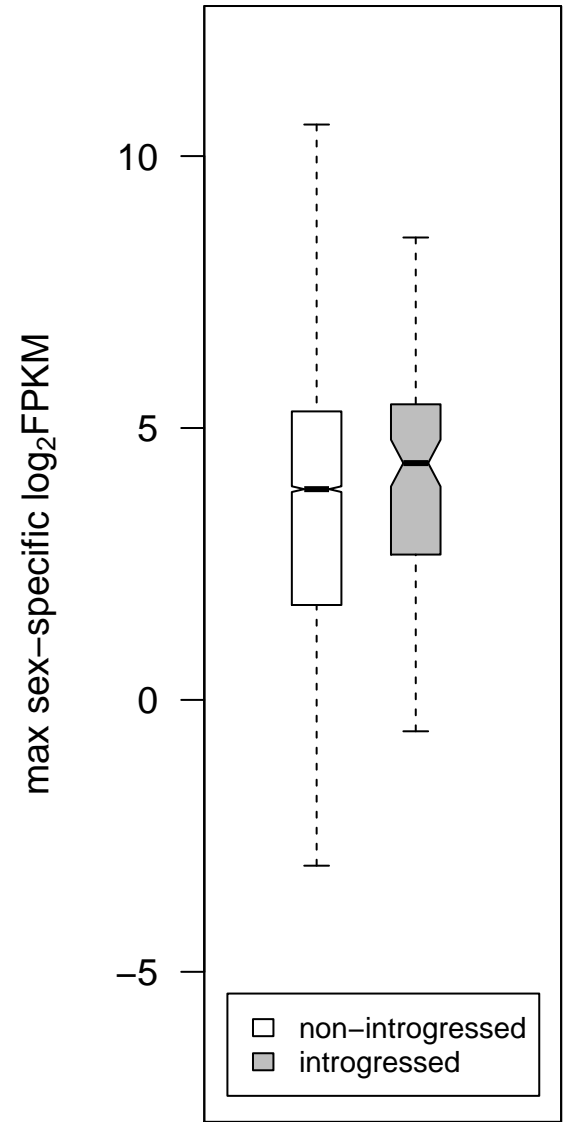
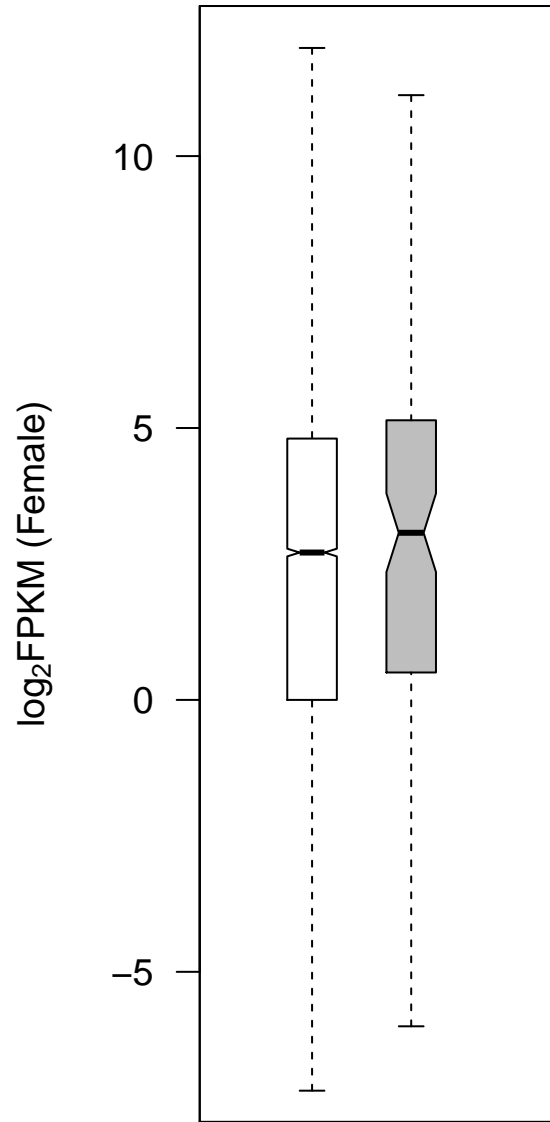
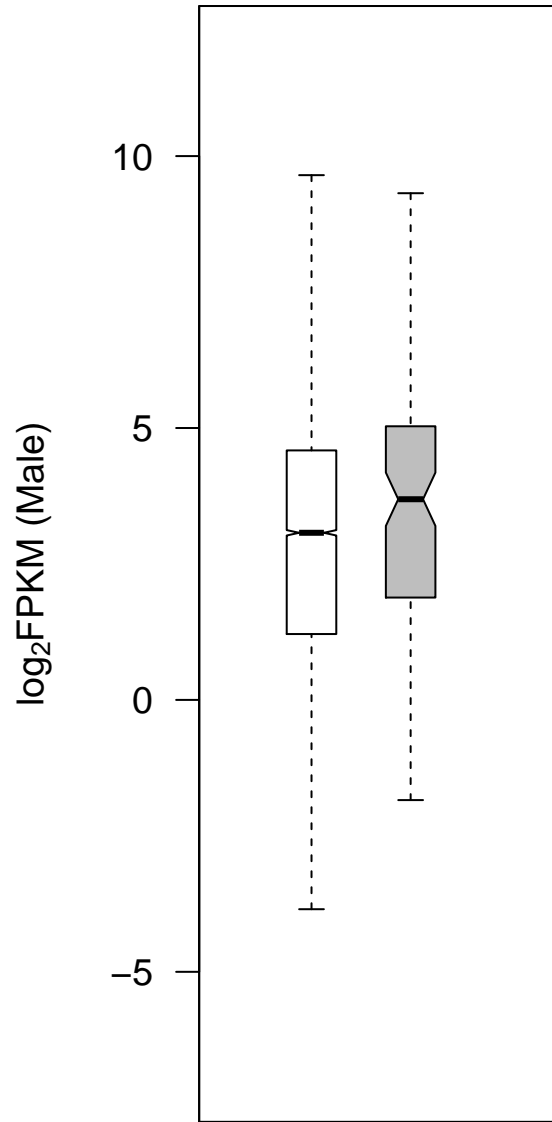

Figure S5

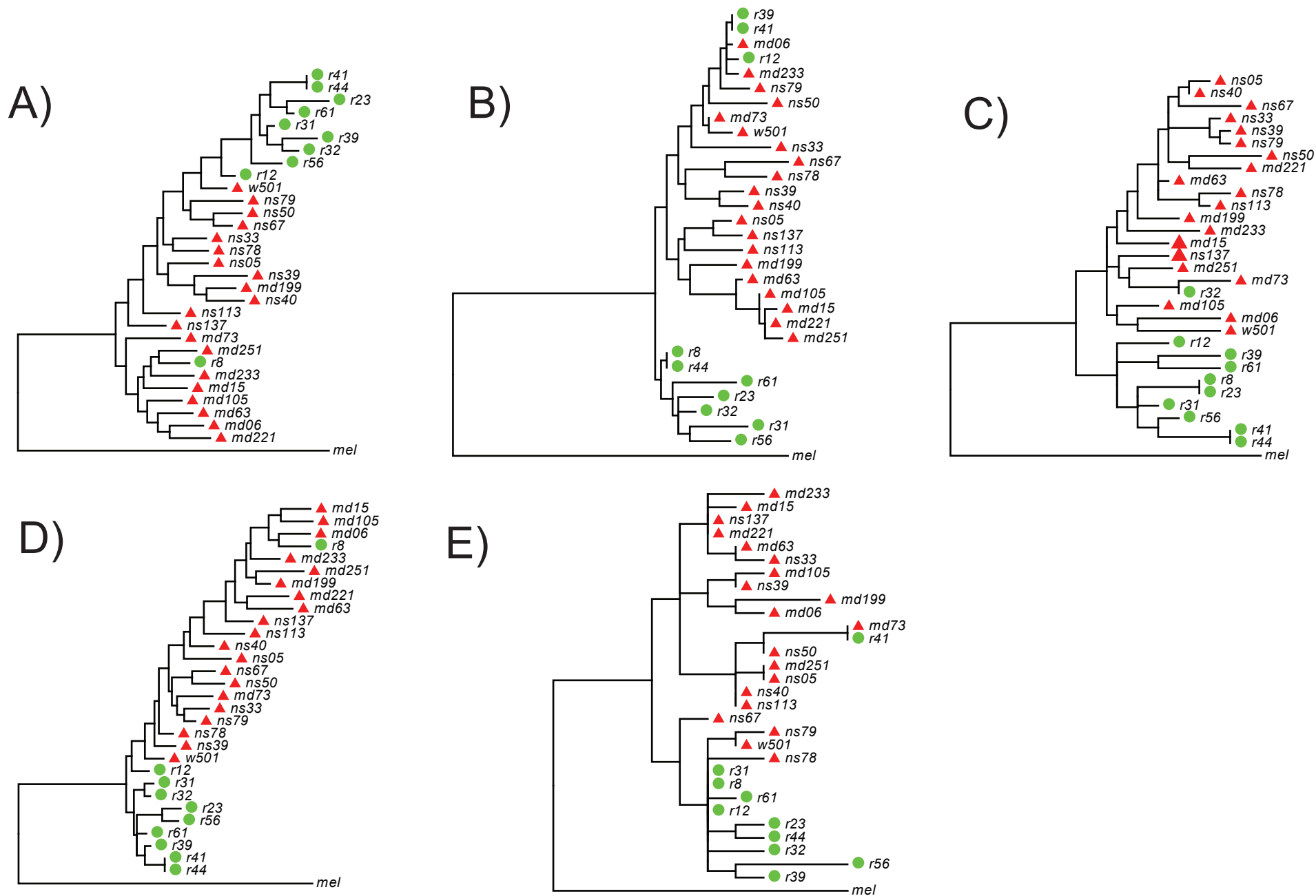

Figure S6